

ARCHITECTURAL SIGNAGE



COSIGN

MODULAR SIGN SYSTEMS & WAY FINDING SOLUTIONS

INTERIOR / INTERIEUR

FLEXIBLE

I-SIGN FLEX	06
I-SIGN FIX	08
FLAG	10
I-SIGN DISPLAY / DISPLAY SLIM	12
STRATO	16
CURVO PLUS	20

MODULAR

MODULE PLUS INDOOR	24
--------------------	----

LED SIGNS

LIGHTBOX	32
HIGHLIGHT	34
SOLED	36
LED LIGHT SHEETS	38

TEXTILE FRAMES

SINGLE & DOUBLE SIDED	40
-----------------------	----

TENSION

TENSION PROFILES	46
------------------	----

FIXINGS & SUSPENSION

INOX & ALUMINIUM FIXINGS	48
SUSPENSION KITS	52

EXTERIOR / EXTERIEUR

MODULAR

MODULE PLUS OUTDOOR	56
---------------------	----

TOTEMS

TOTEM PYLONS	60
--------------	----

HIGH QUALITY

CUSTOMISATION

INNOVATION

LARGE STOCK

EXPERIENCE

FLEXIBLE

SERVICE

QUALITÉ SUPÉRIEURE

PERSONNALISATION

INNOVATION

GRAND STOCK

EXPÉRIENCE

FLEXIBLE

SERVICE

COSIGN

MODULAR SIGN SYSTEMS



YOUR GLOBAL PARTNER IN SIGN

Cosign was established in 1993. Over the last 25 years it has become the unsurpassed reference with regard to architectural signage.

No matter what type of signs you need, for indoor or outdoor use, flexible or modular, with or without LED technology, if desired with fabric, advertising pillars or spacers, Cosign is the right address.

Cosign is a global player with production facilities and distribution centres in Belgium (headquarters), India, Mexico, Brazil and Hong Kong.

Our extensive range of products is unique. We are able to deliver quickly due to our large supply of stock. Twenty years of experience, well-organised logistical transactions and perfect service make Cosign a reliable partner that you can trust.

Cosign constantly works on innovative solutions for the sign industry together with top designers like Stefan Schöning, Bart Bauwens (IDnA) and Fabrique.

VOTRE PARTENAIRE MONDIAL POUR LA SIGNALISATION

Cosign a été fondé en 1993 et au cours de ces 25 dernières années l'entreprise s'est transformée en une référence mondiale dans la signalisation architecturale.

Quel que soit le type de signalisation que vous recherchez - pour une application d'intérieur ou d'extérieur, flexible ou modulaire, avec ou sans technologie LED, avec ou sans toiles de textile, des totems publicitaires ou des entretoises - chez Cosign vous êtes certain d'être à la bonne enseigne.

Cosign est devenu un acteur de classe mondiale avec des facilités de production et de distribution en Belgique (siège principal), en Inde, au Mexique, Brésil et à Hong Kong.

Notre vaste gamme de produits n'est ni plus ni moins qu'unique. Grâce à notre grand stock nous sommes toujours en mesure de livrer rapidement. En sus de nos 20 années d'expérience, notre traitement logistique bien organisé et notre service parfait font que Cosign est un partenaire fiable sur lequel vous pouvez toujours compter.

Epaulé de designers de renom comme Stefan Schöning, Bart Bauwens (IDnA) et Fabrique, Cosign est sans cesse à la recherche de solutions innovantes pour l'industrie de la signalisation.

DOOR SIGNS
 INFORMATION SIGNS
 GENERAL SIGNS
 ORIENTATION SIGNS
 EVACUATION PLANS
 NAMEPLATES

PLAQUES DE PORTE
 PANNEAUX INFORMATIFS
 PANNEAUX SYNOPTIQUES
 PANNEAUX D'ORIENTATION
 PLANS D'ÉVACUATION
 PANNEAUX D'IDENTITÉ



I-SIGN

STRATO

FLEXIBLE AND MULTIFUNCTIONAL

Our flexible sign systems offer the perfect solution for environments where signs and graphics have to be replaced frequently. You can create and update new signs in no time using your printer. You can use paper as well as other materials such as acrylic, metal and engraving plates, or PVC.

The flexible signs are deployed as a wall sign, suspended sign, table stand or as a flag mounted model.

Our flexible systems are not only available as a ready-made product in standard sizes (including the most frequently used DIN and sign sizes). They are also available as a profile system with accessories so the sign maker can put together his/her own signs. You can also request a custom-made product if you order larger quantities.

FLEXIBLE



CURVO PLUS

I-FLAG

FLEXIBLE ET MULTIFONCTION

Nos systèmes de signalisation flexibles offrent la solution parfaite pour les lieux où les signalisations et les graphismes doivent être remplacés souvent. A l'aide de votre imprimante vous pouvez à tout moment créer et remettre à jour vos signalisations et ce en un tour de main. Outre le papier, d'autres supports peuvent être utilisés comme l'acrylate, les plaquettes métalliques et gravées ou le PVC.

Les signalisations flexibles peuvent être utilisées comme panneaux muraux, comme systèmes suspendus, sur table ou comme modèles perpendiculaires (projection).

Nos systèmes flexibles sont disponibles non seulement comme produits prêts pour usage aux dimensions standard (dont les dimensions DIN et de signalisation les plus courantes), mais aussi comme systèmes à profils avec leurs accessoires, qui vous permettent de créer vos propres signalisations. A partir d'un certain volume vous pouvez également faire appel à Cosign pour du travail purement sur mesure.

I-SIGN FLEX



www.cosign.be/isignflex

I-Sign Flex is an intelligent, modern sign system with a few unique characteristics:

1. The top of the acrylic cover plate is at the same level as the top of the aluminium frame with a visible rim of only 2.5 mm.
2. The I-Sign Flex comes with a spring system; this makes it very easy to remove the acrylic plate and replace the insert.
3. When mounting on a wall you can use double-sided tape or adjustable mount buttons.
4. The I-Sign Flex has a lock function to prevent vandalism.

I-Sign Flex est un système de signalisation intelligent et moderne avec quelques caractéristiques uniques:

1. Le dessus de la plaquette de couverture en acrylate se situe dans le même plan que le dessus du châssis en aluminium avec un petit bord visible d'à peine 2,5 mm.
2. L'I-Sign Flex est équipé d'un système à ressort qui facilite le retrait de la plaquette en acrylate afin de remplacer l'encart.
3. Pour un montage mural on peut utiliser aussi bien de la bande adhésive double face que des capuchons muraux adaptables.
4. Pour contrer les actes de vandalisme, l'I-Sign Flex est équipé d'une fonction de sécurité.

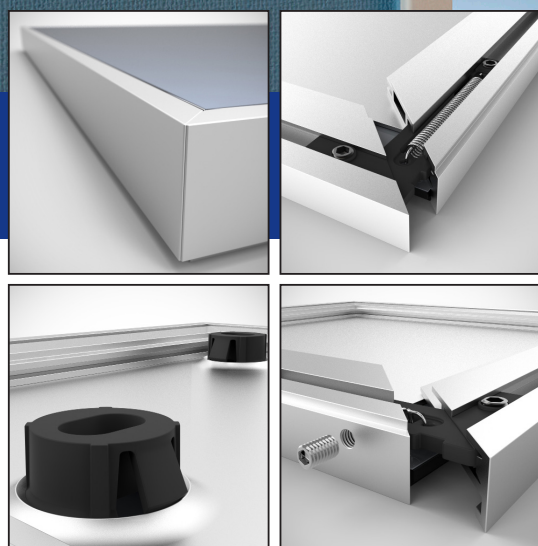

CUSTOM
MADE

COSIGN

READY
MADE

COSIGN

STANDARD SIZES

DIMENSIONS STANDARD

WALL MOUNTED FIXATION MURALE



product code	insert (h x w) in mm / insert (h x l) en mm
I-052148-W	52 x 148,5
I-060210-W	60 x 210
I-105107-W	105 x 107
I-105148-W	105 x 148,5 (DIN A6)
I-105148-WS	105 x 148,5 (DIN A6 slider)
I-148150-W	148,5 x 150,5
I-210148-W	210 x 148,5 (DIN A5)
I-210212-W	210 x 212
I-210297-W	210 x 297 (DIN A4 landscape)
I-297210-W	297 x 210 (DIN A4 portrait)
I-297299-W	297 x 299
I-420297-W	420 x 297 (DIN A3 portrait)
I-594420-W	594 x 420 (DIN A2)
I-841594-W	841 x 594 (DIN A1)

SUSPENDED SYSTÈME DE SUSPENSION



product code	insert (h x w) in mm / insert (h x l) en mm
I-148297-S	148,5 x 297
I-148420-S	148,5 x 420
I-148600-S	148,5 x 600
I-148840-S	148,5 x 840
I-210297-S	210 x 297
I-210420-S	210 x 420
I-210600-S	210 x 600
I-210840-S	210 x 840

PROJECTED FIXATION EN DRAPEAU



product code	insert (h x w) in mm / insert (h x l) en mm
I-150148-P	150,5 x 148,5
I-212210-P	212 x 210
I-210297-P	210 x 297
I-297210-P	297 x 210

TABLE STAND PRÉSENTOIR DE TABLE



product code	insert (h x w) in mm / insert (h x l) en mm
I-052148-T	52 x 148,5

PROFILES & ACCESSORIES

PROFILÉS & ACCESSOIRES

PROJECTING PROFILE PROFILÉ À ANGLE DROIT



product code	description	
FLAG2000	anodised / anodisé	5m/l

PROJECTING BRACKET SUPPORT DE MONTAGE EN DRAPEAU



product code
I-BRACKET

SUCTION CUP VENTOUSE



product code
VACUUMC2

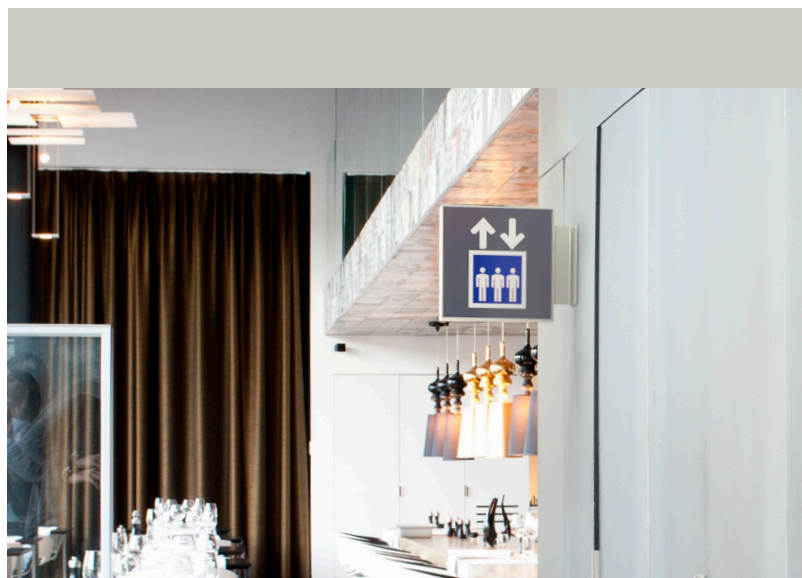

I-SIGN FIX



www.cosign.be/isignfix

The sleek design of the I-Sign range is extended to the I-Sign Fix; observe the elegant frame with invisible fixings.

Sheets of only 2 or 3 mm thick are mounted in the frame with a small, innovative clip. The sheets can be made from various materials: PVC, ACM, acrylic, aluminium, engraving materials, etc. This results in a high degree of personalisation.

Le design élégant de la gamme I-Sign, sans fixation apparente, se retrouve également chez l'I-Sign Fix.

A l'aide d'un petit clip innovant les plaquettes d'une épaisseur de 2 ou 3 mm sont fixées sur le châssis. Différents matériaux peuvent être utilisés pour les plaques : PVC, ACM, acrylate, aluminium, matériaux à graver, etc., permettant un degré élevé de personnalisation.

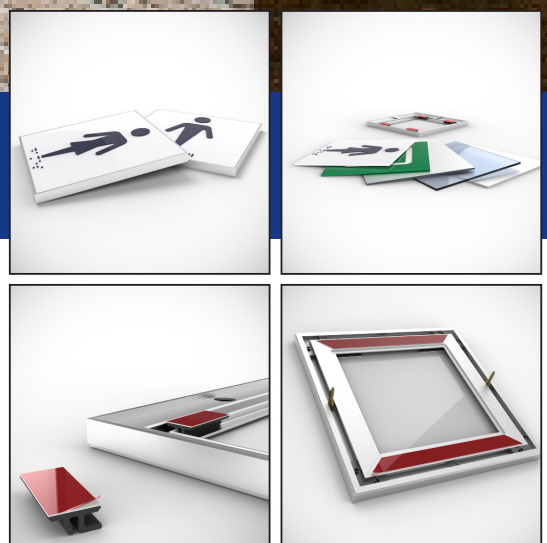

PROFILES & ACCESSORIES
COSIGN

CUSTOM MADE
COSIGN

READY MADE
COSIGN

STANDARD SIZES

DIMENSIONS STANDARD

WALL MOUNTED FIXATION MURALE



product code	insert (hwxw) in mm / insert (lxh) en mm
IF-150150-W	150 x 150
IF-150300-W	150 x 300
IF-150600-W	150 x 600
IF-297210-W	297 x 210 (DIN A4)
IF-297420-W	297 x 420 (DIN A3)

SUSPENDED SYSTÈME DE SUSPENSION



product code	insert (hwxw) in mm / insert (lxh) en mm
IF-150150-S	150 x 150
IF-150300-S	150 x 300
IF-150600-S	150 x 600

PROJECTED FIXATION EN DRAPEAU



product code	insert (hwxw) in mm / insert (lxh) en mm
IF-150150-P	150 x 150
IF-150300-P	150 x 300
I-FLAG	150 x 161

SUCTION CUP / VENTOUSE



product code
VACUUMC2

PROFILES & ACCESSORIES

PROFILÉS & ACCESSOIRES

ALUMINIUM PROFILES PROFILÉS ALUMINIUM



product code	description	
	wall mounted / fixation murale	
IF-WM1000	mill finish / brut	5m/l
IF-WM2000	anodised / anodisé	5m/l
IF-WM5000	black anodised / anodisé noir	5m/l

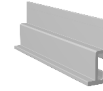

product code	description	
	suspended / suspension	
IF-SP1000	mill finish / brut	5m/l
IF-SP2000	anodised / anodisé	5m/l



product code	description	
	projected / perpendiculaire	
FLAG2000	anodised / anodisé	5m/l

PROJECTING BRACKET SUPPORT DE MONTAGE EN DRAPEAU



product code
I-BRACKET

CORNER SECTION / PIÈCE D'ANGLE



product code
IF-CORNER

MOUNTING CLIP / CLIP DE FIXATION

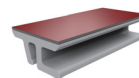

product code
I-CLIP

CONNECTOR / CONNECTEUR



product code
I-CONNECTOR

HANGING CLIP / CLIP DE SUSPENSION



product code
APC-3000S

HANGING KIT / KIT DE SUSPENSION



product code	description
APC4101	2x conical clip + 1,5m wire 2x clip conique + 1,5m fil

See also page 54 for more suspension systems.
Pour plus d'infos sur les systèmes de suspension,
voyez également sur la page 54.

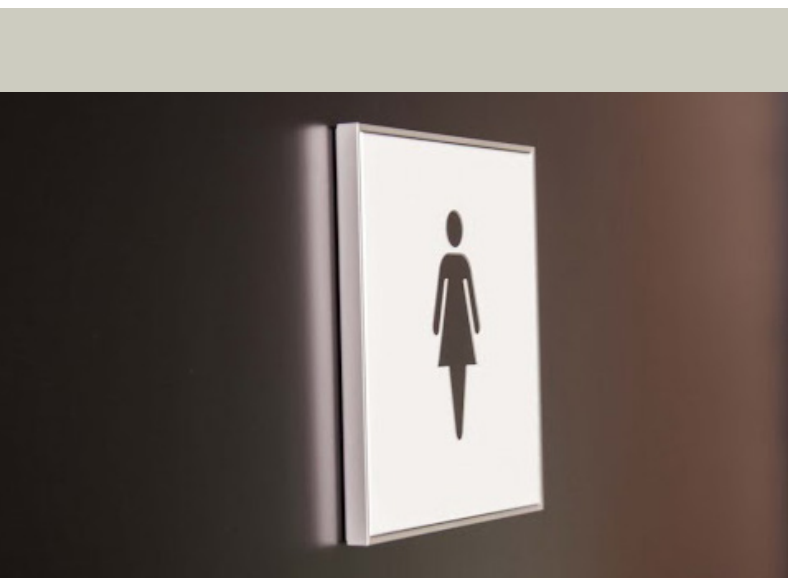

I-FLAG



www.cosign.be/iflag

Cosign developed a universal FLAG profile which can be used as a stand-alone product, to be mounted directly to the wall or ceiling, or in combination with other Cosign products like the I-Sign Eco, I-Sign Flex or I-Sign Fix frames.

First an aluminium mounting profile is fixed to the wall or ceiling, then the flag profile with or without frames mounted on it is slid over the mounting profile and fixed with a set screw.

Cosign a développé un profil, qui s'appelle I-FLAG2 et qui peut être utilisé comme produit autonome - pour être monté directement sur le mur ou le plafond - ou en combinaison avec d'autres produits Cosign comme les cadres I-Sign Eco, I-Sign Flex ou I-Sign Fix.

Tout d'abord, un profil de montage en aluminium est fixé au mur ou au plafond, puis le profil de drapeau - avec ou sans cadres montés dessus - est glissé sur ce profilé de montage et fixé avec une vis de réglage.

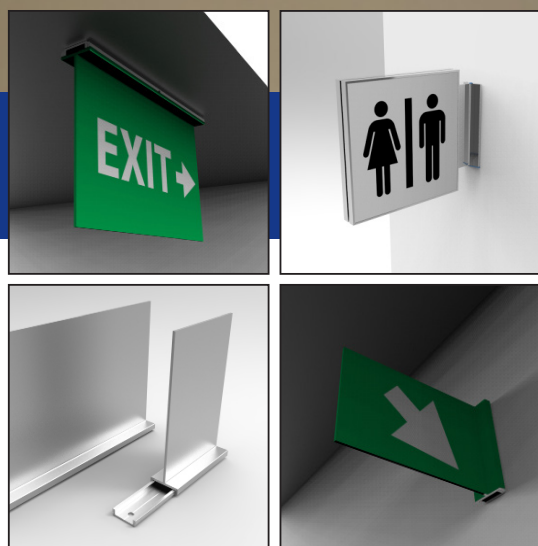

PROFILES & ACCESSORIES
COSIGN

CUSTOM MADE
COSIGN

READY MADE
COSIGN

STANDARD SIZES

DIMENSIONS STANDARD

I-FLAG 1

In combination with I-Sign Fix/Flex
En combinaison avec I-Sign Fix/Flex



product code

I-FLAG1

I-Flag 1 with mount 150mm
I-Flag 1 profilé avec support 150mm

I-FLAG 2



product code

I-FLAG2-150

I-Flag 2 with mount 150mm
I-Flag 2 profilé avec support 100mm

I-FLAG2-300

I-Flag 2 with mount 300mm
I-Flag 2 profilé avec support 150mm

I-FLAG 3



In combination with I-Sign Eco
En combinaison avec I-Sign Eco

product code

I-FLAG3-100

I-Flag 3 with mount 100mm
I-Flag 3 profilé avec support 100mm

I-FLAG3-150

I-Flag 3 with mount 150mm
I-Flag 3 profilé avec support 150mm

PROFILES & ACCESSORIES

PROFILÉS & ACCESSOIRES

FLAG1-2000



product code

FLAG1-2000

anodised / anodisé

5m/l

PROJECTING BRACKET SUPPORT DE MONTAGE EN DRAPEAU



product code

I-BRACKET

Bracket for Flag1-2000
Support pour Flag1-2000

FLAG2-2000



product code

FLAG2-2000

anodised / anodisé

5m/l

MOUNT2-1000

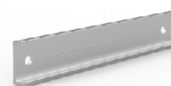

product code

MOUNT2-1000

mill finish / brut

5m/l



I-SIGN DISPLAY



www.cosign.be/isigndisplay

The single-sided I-Sign Display profiles make it possible to frame large panels, digital prints and art virtually without an edge and without visible fixings. This makes them very suitable for use in museums, galleries and interior decoration.

The double-sided profile is extremely suitable for making thin light boxes and illuminated or non-illuminated indoor pillars.

Double-sided tape, magnetic tape or the 3M Dual Lock™ reclosable fastener can be used to affix the panels.



Les profils I-Sign Display à simple face permettent d'encadrer pratiquement sans bords les grands panneaux, les impressions numériques et les affiches artistiques, ce qui les rend appropriés pour des applications dans les musées, les galeries et pour les décorations d'intérieur.

Le profil à double face convient tout particulièrement pour la réalisation de caissons lumineux minces et de petites colonnes d'intérieur, avec ou sans éclairage.

Pour la fixation des panneaux il est possible d'utiliser aussi bien des bandes magnétiques que du Velcro ou le Dual Lock™ refermable de 3M ou bien des bandes adhésives double face.



SINGLE-SIDED

SIMPLE FACE

ALUMINIUM PROFILE / PROFILÉ ALUMINIUM

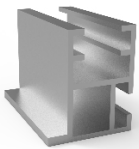

product code	description	
ID-SS1000	mill finish / brut	5m/l
ID-SS2000	anodised / anodisé	5m/l
ID-SS5000	black anodised / anodisé noir	5m/l

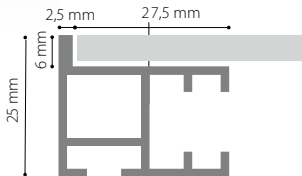

CORNER CONNECTOR / RACCORD D'ANGLE



product code
ID-SS CORNER

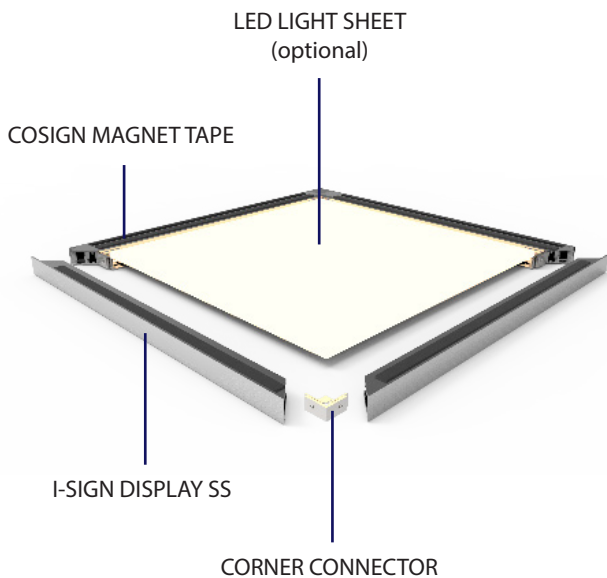

DOUBLE-SIDED SLIM

DOUBLE FACE SLIM

ALUMINIUM PROFILE / PROFILÉ ALUMINIUM

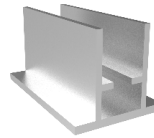

product code	description	
ID-SLIM1000	mill finish / brut	5m/l
ID-SLIM2000	anodised / anodisé	5m/l

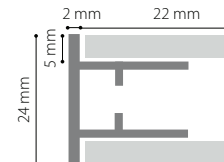

CORNER CONNECTOR / RACCORD D'ANGLE



product code
ID-SL CORNER

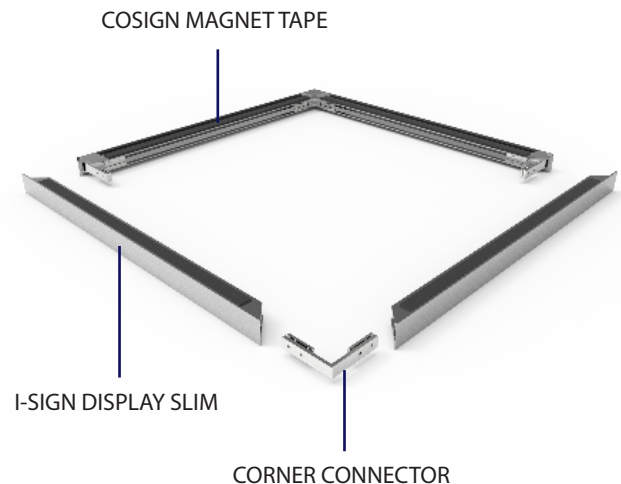

MAGNETIC STRIPS / STRIPS MAGNÉTIQUES



product code	description	
MAG12.7/1.5A5	isotropic A, 5 poles	12,7 x 1,5 mm
MAG12.7/1.5B5	isotropic B, 5 poles	12,7 x 1,5 mm
MAG25.4/1.5A9	isotropic A, 9 poles	25,4 x 1,5 mm
MAG25.4/1.5B9	isotropic B, 9 poles	25,4 x 1,5 mm
MAG12.7/1.0A5	anisotropic A, 5 poles	12,7 x 1 mm
METAL13	metal strip	13 x 0,22 mm
METAL25	metal strip	25 x 0,22 mm

DOUBLE-SIDED

DOUBLE FACE

ALUMINIUM PROFILE / PROFILÉ ALUMINIUM

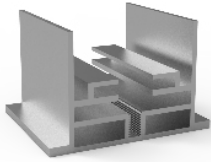

product code	description	
ID-DS1000	mill finish / brut	5m/l
ID-DS2000	anodised / anodisé	5m/l
ID-DS5000	black anodised / anodisé noir	5m/l

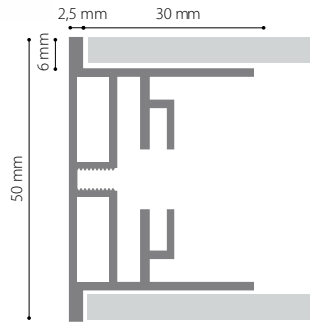

CORNER CONNECTOR / RACCORD D'ANGLE



product code
ID-DS CORNER

COSIGN MAGNET TAPE

LUCOLED EL31

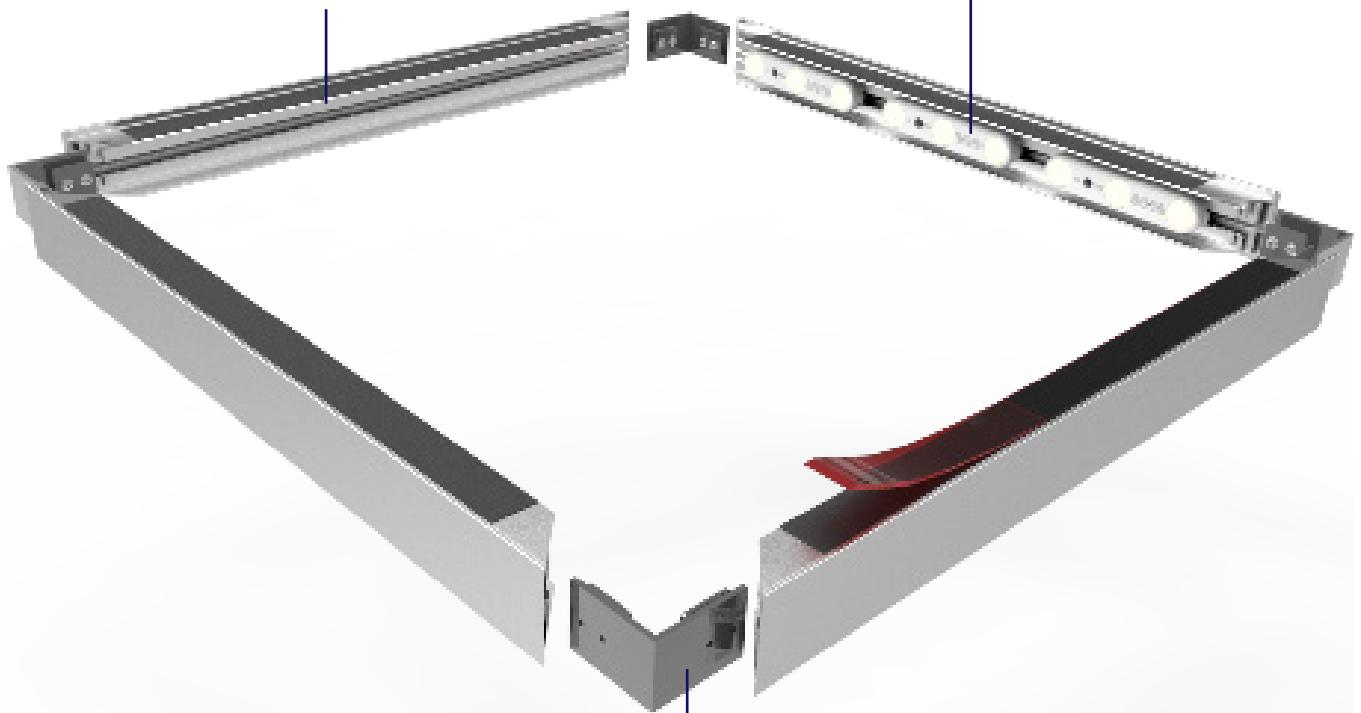

CORNER CONNECTOR



LUCOLED
Experience Lighting

LUCOLED EL31



product code	description	
EL31-W65	12 VDC	327lm / module
		2,88W / module

POWER SUPPLY / SOURCE D'ALIMENTATION



product code	description	
PPS1230	Lucoled Slim 12 VDC / 30W	
PPS1260	Lucoled Slim 12 VDC / 60W	
PPS12100	Lucoled Slim 12 VDC / 100W	
PP12150	Lucoled 12 VDC / 150W	
PP12200	Lucoled 12 VDC / 200W	

STRATO



www.cosign.be/strato

STRATO is a flexible and contemporary sign system consisting of a series of soft curved profiles with square sides.

A paper inlay (in the most common DIN formats) can be inserted in the profiles behind a non-reflecting acrylic cover. Other inserts in plastic or metal are of course also possible as well as direct signage or printing on the profiles.

The user can choose between plastic and aluminium end caps for the finish. Recently, a few profiles and end caps were added to the range that ensure that 400 mm, 500 mm and 600 mm wide directories can be produced.

STRATO est un système de signalisation flexible et contemporain qui se compose d'une série de profilés légèrement galbés avec des côtés rectilignes.

Les profilés peuvent accueillir un support de données en papier (dans les formats DIN les plus courants) inséré derrière une plaquette protectrice non-réfléchissante en acrylic. D'autres types d'inserts, en plastique ou en métal, sont naturellement également envisageables, de même qu'un lettrage ou une impression directement apposés sur les profilés.

Pour la finition, l'utilisateur a le choix entre des capuchons en plastique ou en aluminium. Récemment, plusieurs profilés et capuchons ont été ajoutés à la gamme afin de pouvoir réaliser des panneaux d'affichage directionnels d'une largeur de 400, 500 ou 600 mm.

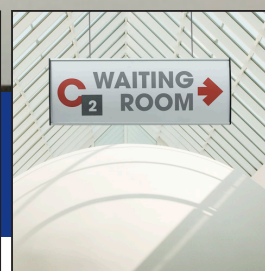

STANDARD SIZES / STANDARDMAÅB

WALL MOUNTED FIXATION MURALE



product code	insert (hxw) in mm / insert (hxl) en mm		
ST-056074-W	53	x 74 (DIN A8)	
ST-056105-W	53	x 105	
ST-056150-W	53	x 150	56mm
ST-056210-W	53	x 210	
ST-056297-W	53	x 297	
ST-078105-W	74	x 105 (DIN A7)	
ST-078150-W	74	x 150	
ST-078210-W	74	x 210	78mm
ST-078297-W	74	x 297	
ST-078420-W	74	x 420	
ST-109105-W	105	x 105	
ST-109150-W	105	x 150 (DIN A6)	
ST-109210-W	105	x 210	109mm
ST-109297-W	105	x 297	
ST-109420-W	105	x 420	
ST-150105-W	148	x 105 (DIN A6)	
ST-150150-W	148	x 150	
ST-150210-W	148	x 210 (DIN A5)	150mm
ST-150297-W	148	x 297	
ST-150420-W	148	x 420	
ST-212148-W	210	x 148 (DIN A5)	
ST-212210-W	210	x 210	212mm
ST-212297-W	210	x 297	
ST-212420-W	210	x 420	
ST-300210-W	297	x 210 (DIN A4)	
ST-300420-W	297	x 420 (DIN A3)	300mm
ST-300600-W	297	x 600	

PROJECTED FIXATION EN DRAPEAU



product code	insert (hxw) in mm / insert (hxl) en mm		
ST-109148-P	105	x 148 (DIN A6)	109mm
ST-109210-P	105	x 210	
ST-150150-P	148	x 150	
ST-150210-P	148	x 210 (DIN A5)	150mm
ST-150297-P	148	x 297	
ST-212210-P	210	x 210	212mm
ST-212297-P	210	x 297 (DIN A4)	

TABLE STAND PRÉSENTOIR DE TABLE



product code	insert (hxw) in mm / insert (hxl) en mm		
ST-078105-T	74	x 105 (DIN A7)	78mm
ST-078150-T	74	x 150	
ST-109075-T	105	x 74	
ST-109148-T	105	x 148 (DIN A6)	109mm
ST-109210-T	105	x 210	
ST-109297-T	105	x 297	

SUSPENDED SYSTÈME DE SUSPENSION

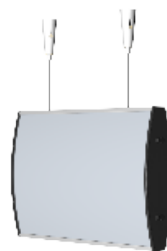

product code	insert (hxw) in mm / insert (hxl) en mm		
ST-109210-S	105	x 210	
ST-109297-S	105	x 297	109mm
ST-109420-S	105	x 420	
ST-109600-S	105	x 600	
ST-150297-S	148	x 297	
ST-150420-S	148	x 420	150mm
ST-150600-S	148	x 600	
ST-150840-S	148	x 840	
ST-212297-S	210	x 297	
ST-212420-S	210	x 420	212mm
ST-212600-S	210	x 600	
ST-212840-S	210	x 840	

SUSPENDED MULTI-LEVEL SYSTÈME DE SUSPENSION MULTI-LEVEL







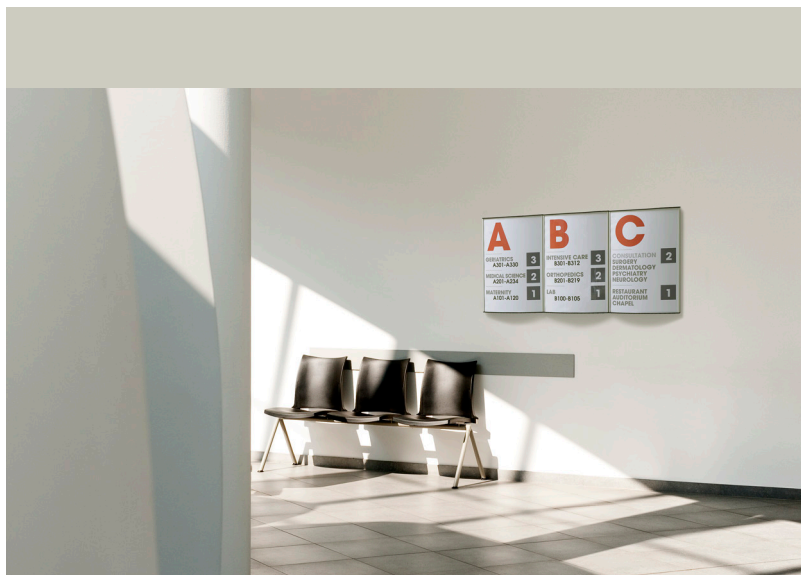





product code	insert (hxw) in mm / insert (hxl) en mm		
ST-109210-SD	105	x 210	
ST-109297-SD	105	x 297	109mm
ST-109420-SD	105	x 420	
ST-109600-SD	105	x 600	
ST-150297-SD	148	x 297	
ST-150420-SD	148	x 420	150mm
ST-150600-SD	148	x 600	
ST-150840-SD	148	x 840	
ST-212297-SD	210	x 297	
ST-212420-SD	210	x 420	212mm
ST-212600-SD	210	x 600	
ST-212840-SD	210	x 840	
STRATOCON-2	Connectors / Connecteurs (2pcs)		
STRATOCON-4	Connectors / Connecteurs (4pcs)		

Example suspended system / Exemple de système de suspension 150 x 600mm, 2 levels/2 niveaux:
ST-150600-S + STRATOCON-2 + ST-150600-SD





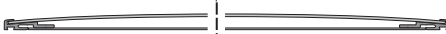



PROFILES & ACCESSORIES / PROFILÉS & ACCESSOIRES

ALUMINIUM PROFILES PROFILÉS ALUMINIUM

	product code	profile	insert (hwx) / insert (lxx)	
	STRATO 2 0A8	56mm	DIN A8 (53mm)	5m/l
	STRATO 2 0A7	78mm	DIN A7 (74mm)	5m/l
	STRATO 2 0A6	109mm	DIN A6 (105mm)	5m/l
	STRATO 2 0A5	150mm	DIN A5 (148mm)	5m/l
	STRATO 2 0A4	212mm	DIN A4 (210mm)	5m/l
			DIN A3 (297mm)	5m/l
	STRATO 2 0A3S	edge profile / profilé latéral		5m/l
	STRATO 2 0A3M	mid profile / section médiane		5m/l
		all sizes / toutes les tailles		
	STRATOBS20	universal edge profile profilé latéral universel		5m/l

PLASTIC ENDCAPS CAPUCHONS PLASTIQUES

	product code	description
	STRATOCAP3A8	A8, black / noir
	STRATOCAP3A7	A7, black / noir
	STRATOCAP3A6	A6, black / noir
	STRATOCAP3A5	A5, black / noir
	STRATOCAP3A4	A4, black / noir
	STRATOCAP3A3	A3, black / noir

2. grey/gris 3. black/noir

ALUMINIUM ENDCAPS CAPUCHONS ALUMINIUM

	product code	description
	STRALUCAPA8	A8 single-sided / simple face
	STRALUCAPA8D	A8 double-sided / double face
	STRALUCAPA7	A7 single-sided / simple face
	STRALUCAPA7D	A7 double-sided / double face
	STRALUCAPA6	A6 single-sided / simple face
	STRALUCAPA6D	A6 double-sided / double face
	STRALUCAPA5	A5 single-sided / simple face
	STRALUCAPA5D	A5 double-sided / double face
	STRALUCAPA4	A4 single-sided / simple face
	STRALUCAPA4D	A4 double-sided / double face
	STRALUCAPA3	A3 single-sided / simple face
	STRALUCAPA3D	A3 double-sided / double face
	STRALUCAP400	400mm single-sided / simple face
	STRALUCAP500	500mm single-sided / simple face
	STRALUCAP600	600mm single-sided / simple face

DIRECTORY / PANNEAU D'AFFICHAGE

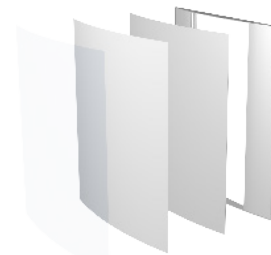

Directory example / Exemple de panneau d'affichage 400x600mm:
2x STRATO20A3S + 2x STRALUCAP400

WALL MOUNTED FIXATION MURALE

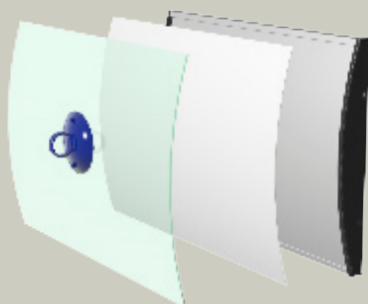

SUSPENDED SYSTÈME DE SUSPENSION

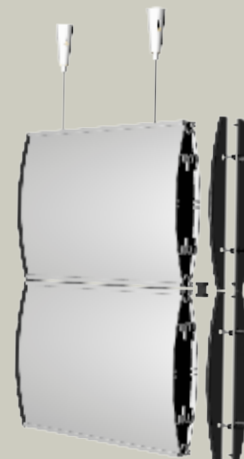

ACCESSORIES / ACCESSOIRES

TABLE STAND / PRÉSENTOIR DE TABLE



product code	description
STRATOTS3A7	A7 black / noir
STRATOTS3A6	A6 black / noir
STRATOTS3UNI	universal black / universel noir

↳ 2. grey/gris 3. black/noir

PROJECTING BRACKET SUPPORT DE MONTAGE EN DRAPEAU



product code	description
STRATOBACA6	A6 anodised / anodisé
STRATOBACA5	A5 anodised / anodisé
STRATOBACA4	A4 anodised / anodisé

ANTI-REFLEX PET STRIPS FEUILLES ANTI-REFLET PET



product code	description
STRATOSTRIP8	1250 x 52,5 x 0,6mm
STRATOSTRIP7	1250 x 74 x 0,6mm
STRATOSTRIP6	1250 x 106 x 0,6mm
STRATOSTRIP5	1250 x 147,5 x 0,6mm
STRATOSTRIP4	1250 x 209,5 x 1mm
STRATOSTRIP3	1250 x 297 x 1mm

ALUMINIUM SLIDER PROFILE / PROFILÉ GLISSIÈRES EN ALUMINIUM

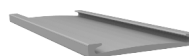

product code	description
SLIDERRCS	slider profile. 2,5m profilé glissières. 2,5m

SCREWS / VIS



product code	description
SCREW003	↳ 2. grey/gris 3. black/noir

HANGING CLIP / CLIP DE SUSPENSION



product code	description
APC3000S	

CONNECTOR / CLIP DE CONNEXION



product code	description
STRATOCON3	

HANGING KIT / KIT DE SUSPENSION



product code	description
APC4101	2x conical clip + 1,5m wire 2x clip conique + 1,5m fil

See also page 54 for more suspension systems.
Pour plus d'infos sur les systèmes de suspension,
voyez également sur la page 54.

PROJECTED FIXATION EN DRAPEAU

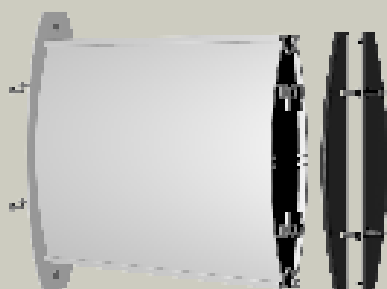

TABLE STAND PRÉSENTOIR DE TABLE



CURVO PLUS



www.cosign.be/curvoplus

Curvo Plus is a modern, indoor sign system made from high-quality aluminium and executed in a stylish design with gently curved profiles and rounded corners.

The tabs with a stainless steel look keep the signs and the anti-reflective covers in place and give the signs extra cachet.

Moreover, the tabs are the same for all profiles. This limits the number of components and simplifies installation. It is possible to inscribe or print directly on the profiles.



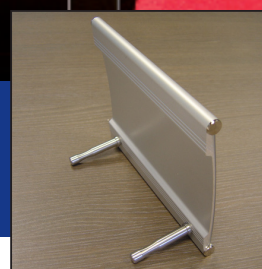

CURVO PLUS est un système d'enseigne d'intérieur qui combine flexibilité, simplicité et élégance, fabriqués à partir d'un aluminium de qualité supérieure et réalisés avec un design stylé avec des profils légèrement galbés et des angles arrondis.

Les clous d'apparence inox maintiennent en place les porteurs de données et les plaquettes de couverture anti-reflet, mais en plus elles donnent un cachet supplémentaire à votre signalétique.

De plus, les trous conviennent pour tous les profils, ce qui réduit le nombre des différents éléments et facilite l'installation. Il est également possible d'appliquer le lettrage ou d'imprimer directement sur les profilés.

STANDARD SIZES / DIMENSIONS STANDARD

WALL MOUNTED FIXATION MURALE

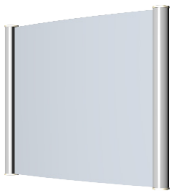

product code	insert (wxh) in mm / insert (lxh) en mm		
CV-104150-W	89	x 150	104mm
CV-104210-W	89	x 210	
CV-104297-W	89	x 297	
CV-104420-W	89	x 420	
CV-134150-W	119	x 150	134mm
CV-134210-W	119	x 210	
CV-134297-W	119	x 297	
CV-134420-W	119	x 420	
CV-164105-W	149	x 105 (DIN A6)	164mm
CV-164150-W	149	x 150	
CV-164210-W	149	x 210 (DIN A5)	
CV-164297-W	149	x 297	
CV-164420-W	149	x 420	
CV-224150-W	210	x 150	224mm
CV-224297-W	210	x 297 (DIN A4)	
CV-312210-W	297	x 210 (DIN A4)	312mm
CV-312420-W	297	x 420 (DIN A3)	

PROJECTED FIXATION EN DRAPEAU



product code	insert (wxh) in mm / insert (lxh) en mm		
CV-104090-P	89	x 90	104mm
CV-134120-P	119	x 120	134mm
CV-134240-P	119	x 240	
CV-164150-P	149	x 150	164mm
CV-164297-P	149	x 297	
CV-224210-P	210	x 210	224mm

SUSPENDED SYSTÈME DE SUSPENSION



product code	insert (wxh) in mm / insert (lxh) en mm		
CV-104420-S	89	x 420	104mm
CV-104600-S	89	x 600	
CV-134420-S	119	x 420	134mm
CV-134600-S	119	x 600	
CV-164150-S	149	x 150	164mm
CV-164297-S	149	x 297	
CV-164600-S	149	x 600	
CV-164840-S	149	x 840	
CV-224297-S	210	x 297	224mm
CV-224600-S	210	x 600	
CV-224840-S	210	x 840	

TABLE STAND PRÉSENTOIR DE TABLE



product code	insert (wxh) / insert (lxh) en mm		
CV-164074-T	149	x 74	164mm
CV-164105-T	149	x 105 (DIN A6)	
CV-224074-T	210	x 74	224mm
CV-224105-T	210	x 105	

SUCTION CUP VENTOUSE



product code
VACUUMC2

WALL MOUNTED FIXATION MURALE









SUSPENDED SYSTÈME DE SUSPENSION





PROFILES & ACCESSORIES / PROFILÉS & ACCESSOIRES





ALUMINIUM PROFILES PROFILÉS ALUMINIUM

	product code	profile	insert (wxh) / insert (lxh) en mm	
	CURVO 2 090	104mm	89mm	5m/l
	CURVO 2 120	134mm	119mm	5m/l
	CURVO 2 150	164mm	149mm	5m/l
	CURVO 2 210	224mm	210mm (DIN A4)	5m/l
	CURVO 2 297	312mm	297mm (DIN A3)	5m/l
				
	CURVO BS20	universal side profile profilé latéral universel		5m/l

TABS / CLOUS

	product code	description
	TAB001	inox-look / clous d'apparence inox
	TAB002	baseplate / plaque de base + 2x TAB002





ALUMINIUM ENDCAPS CAPUCHONS ALUMINIUM

	product code	description
	CURCAP90	90mm double-sided / double face
	CURCAP120	120mm double-sided / double face
	CURCAP150	150mm double-sided / double face
	CURCAP210	210mm double-sided / double face

INOX STANDARD PRÉSENTOIR DE TABLE EN INOX

	product code
	CURVOTS

PROJECTING BRACKET SUPPORT DE MONTAGE EN DRAPEAU

	product code	description
	CURBRAC90	support / support: 90mm
	CURBRAC120	support / support: 120mm
	CURBRAC150	support / support: 150mm
	CURBRAC210	support / support: 210mm

HANGING KIT / KIT DE SUSPENSION

	product code	description
	APC4101	2x conical clip + 1,5m wire 2x clip conique + 1,5m fil

See also page 54 for more suspension systems.
Pour plus d'infos sur les systèmes de suspension,
voyez également sur la page 54.

ANTI-REFLEX PET STRIPS FEUILLES ANTI-RÉFLET PET

	product code	description
	STRIP89	1250 x 89 x 0,6mm
	STRIP119	1250 x 119 x 0,6mm
	STRIP149	1250 x 149 x 1mm
	STRIP209	2050 x 209 x 2mm
	STRIP297	2050 x 297 x 2mm

PROJECTED

FIXATION EN DRAPEAU

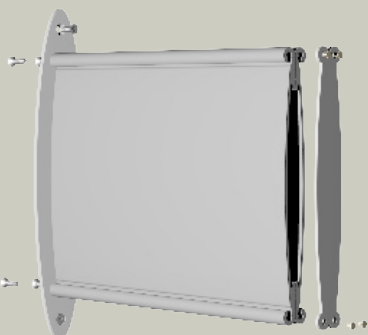

TABLE STAND

PRÉSENTOIR DE TABLE



MODULE PLUS INDOOR



www.cosign.be/moduleplusindoor

A CLASSIC PRODUCT THAT CONTINUES TO DO THE JOB PERFECTLY!

With the Module Plus Indoor, Cosign developed a modular sign system at the beginning of the 1990s that started a new trend within architectural signage and served as an inspiration for many of our colleagues.

The Module Plus Indoor consists of a series of flat aluminium profiles in different widths that has a 15,5 mm and 31 mm module as the basic profiles. The profiles can be "clicked" into place in an easy manner on plastic end caps or clips to create door signs, pictograms, directories, etc. Single-sided signs for wall mounting and double-sided systems for hanging or flag mounting are possible.

The Module Plus Indoor platform does not just offer the sign maker a simple, versatile and flexible standard solution, it also offers space to the creative sign maker to place his or her own emphasis and to develop customised products.



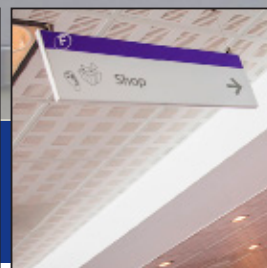
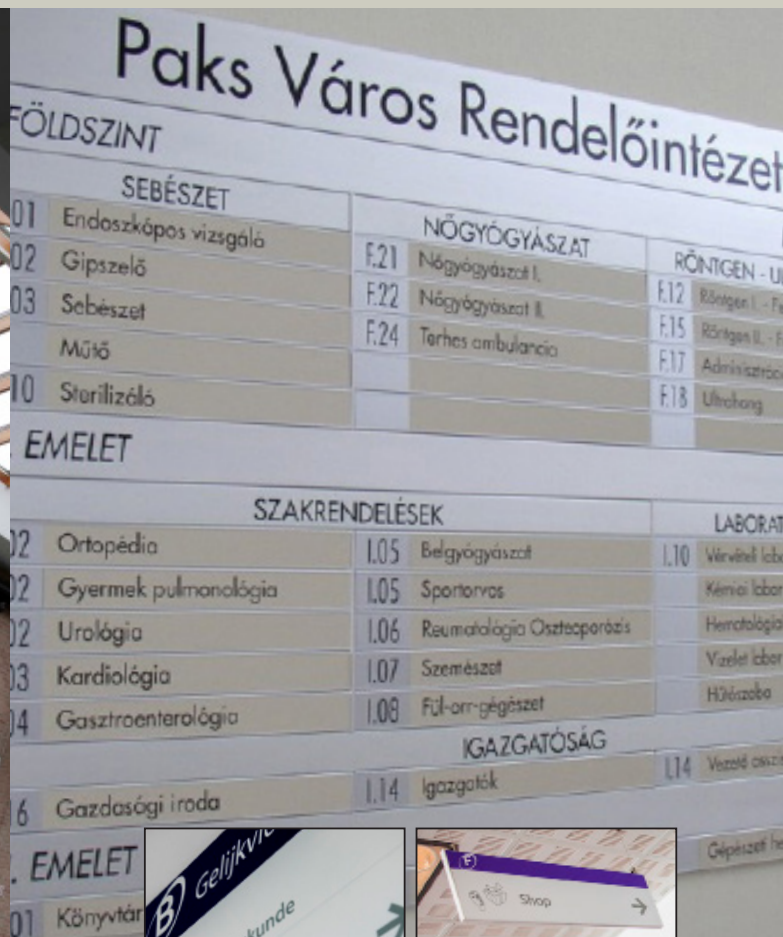

UN GRAND CLASSIQUE QUI DONNE ENCORE TOUJOURS ENTIÈRE SATISFACTION !

Au début des années '90, Cosign a mis au point le Module Plus Indoor pour développer un nouveau système d'enseigne modulaire. Celui-ci a créé une nouvelle tendance dans le secteur de la signalisation architecturale et a servi de source d'inspiration pour de nombreux collègues.

Le Module Plus Indoor se compose d'une série de profilés plats en aluminium de différentes largeurs, avec le modules de 15,5mm et 31 mm faisant figure de profilé de base. Les profilés s'emboîtent très facilement sur des embouts ou des clips en plastique de façon à créer des enseignes de porte, des pictogrammes, des panneaux d'affichage, etc. Le système permet de créer des panneaux simple face à apposer sur un mur, de même que des systèmes double face à suspendre au plafond ou à fixer en drapeau au mur.

La plate-forme Module Plus Indoor offre aux fabricants d'enseignes non seulement une solution standard flexible, simple et polyvalente, mais donne également au designer la possibilité d'ajouter sa touche créative personnelle et de développer des produits fabriqués sur mesure.

PROFILES & ACCESSORIES / PROFILÉS & ACCESSOIRES

ALUMINIUM TEXT PROFILES PROFILÉS ALUMINIUM

product code	profile	
ANO 1 300	300 mm mill finish / brut	5m/l
ANO 1 250	250 mm mill finish / brut	5m/l
ANO 1 187	187 mm mill finish / brut	5m/l
ANO 1 156	156 mm mill finish / brut	5m/l
ANO 1 125	125 mm mill finish / brut	5m/l
ANO 1 093	93 mm mill finish / brut	5m/l
ANO 1 062	62 mm mill finish / brut	5m/l
ANO 1 046	46,5 mm mill finish / brut	5m/l
ANO 1 031	31 mm mill finish / brut	5m/l
ANO 1 015	15,5 mm mill finish / brut	5m/l

1. mill finish brut
2. silver anodised anodisé naturel
3. color colour
4. gold anodised anodisé d'or

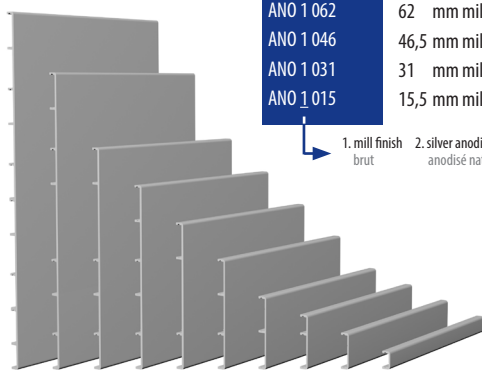

300 250 187 156 125 93 62 46,5 31 15,5 mm

ALUMINIUM SLIDER PROFILE PROFILÉS GLISSIÈRES EN ALUMINIUM

product code	profile profilé	insert insert	thickness épaisseur
ASO 1 093	93 mm	89,5 mm	≤ 1,6 mm
ASO 1 062	62 mm	58 mm	≤ 1,6 mm
ASO 1 046	46,5 mm	42,5 mm	≤ 1,2 mm
ASO 1 031	31 mm	27 mm	≤ 1,0 mm
ASO 1 015	15,5 mm	11,5 mm	≤ 1,0 mm

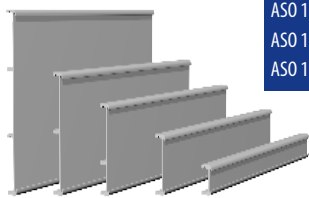

93 62 46,5 31 15,5 mm

ASO 1 031.SP	31 mm	custom	≤ 1,2 mm
--------------	-------	--------	----------

1. mill finish brut
2. silver anodised anodisé naturel
3. color colour
4. gold anodised anodisé d'or



SINGLE SIDED ENDCAPS CLIPS SIMPLE FACE

product code	description
APE 3 250	250 mm black / noir
APE 3 218	218 mm black / noir
APE 3 187	187 mm black / noir
APE 3 156	156 mm black / noir
APE 3 125	125 mm black / noir
APE 3 093	93 mm black / noir
APE 3 062	62 mm black / noir
APE 3 046	46,5 mm black / noir
APE 3 031	31 mm black / noir
APE 3 015	15,5 mm black / noir

1. white/blanc 2. grey/gris 3. black/noir

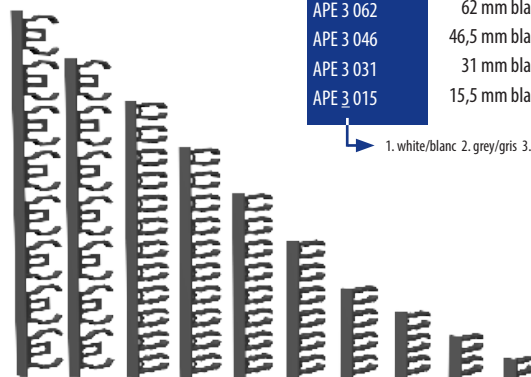

250 218 187 156 125 93 62 46,5 31 15,5 mm

DOUBLE SIDED ENDCAPS CLIPS DOUBLE FACE

product code	description
APD 3 300	300 mm black / noir
APD 3 250	250 mm black / noir
APD 3 187	187 mm black / noir
APD 3 156	156 mm black / noir
APD 3 125	125 mm black / noir
APD 3 093	93 mm black / noir
APD 3 062	62 mm black / noir

1. white/blanc 2. grey/gris 3. black/noir

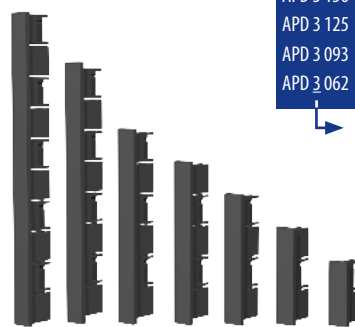

300 250 187 156 125 93 62 mm

WALL MOUNTED FIXATION MURALE

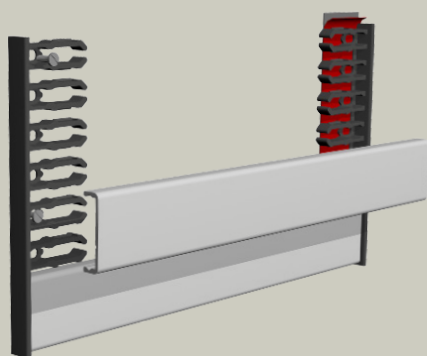

PROJECTED FIXATION EN DRAPEAU

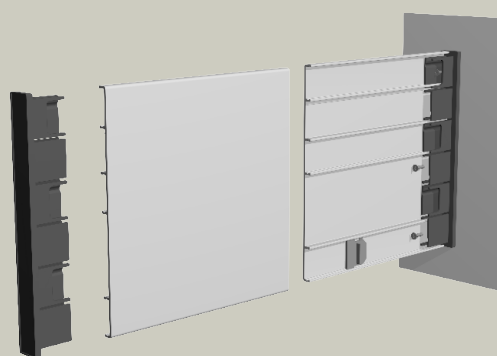

ACCESSORIES / ACCESSOIRES

HANGING KIT / KIT DE SUSPENSION



product code	description
APC4101	2x conical clip + 1,5m wire 2x clip conique + 1,5m fil

See also page 54 for more suspension systems.
Pour plus d'infos sur les systèmes de suspension, voyez également sur la page 54.



product code	description
APC 3 000	plastic suspension clip / clip suspension plastique
	2. grey/gris 3. black/noir

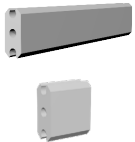

product code	description
APC 4 400	metal suspension profil / profil de jonction (5m)
APC 4 500	metal suspension clip / clip suspension metal (30mm)



product code	description
APC 6 000	wedge ABS black / cale ABS noir

SUCTION CUP VENTOUSES



product code
VACUUMC2
VACUUMC

KEY CLÉ DE DÉMONTAGE



product code
APK1000

TABLE STAND CHEVALET DE BUREAU



product code	description
APW7000	wedge / cale chevalet



product code	description
APW 3 031	triangular endcap / triangle chevalet 31mm
	1. white/blanc 2. grey/gris 3. black/noir

product code	description
APW 3 062	triangular endcap / triangle chevalet 62mm
	2. grey/gris 3. black/noir

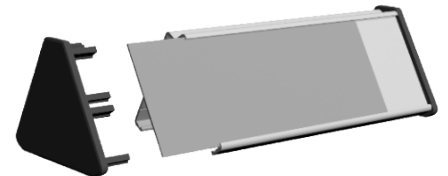
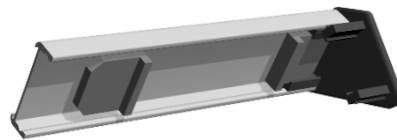

SUSPENDED SYSTÈME DE SUSPENSION

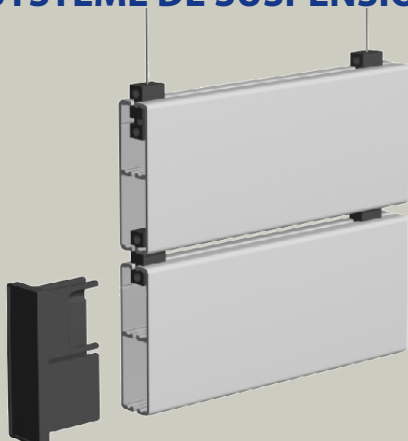
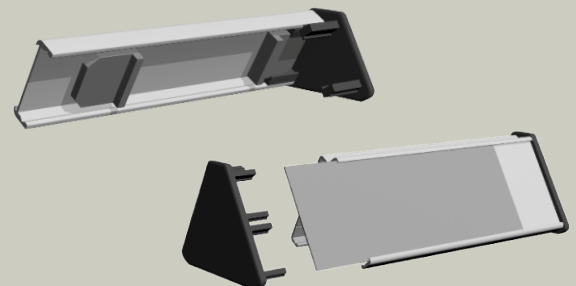
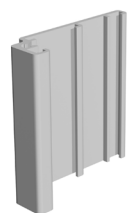

TABLE STAND CHEVALET DE BUREAU



PROFILES / PROFILÉS

ALUMINIUM SIDE PROFILES PROFILÉS LATÉRAUX EN ALUMINIUM



product code description
AEO 1 000 straight / droit
 1. mill finish 2. silver anodised 3. color 4. gold anodised
 brut anodisé naturel couleur anodisé d'or



product code description
AEO 1 000T triangular / triangle
 1. mill finish 2. silver anodised 3. color 4. gold anodised
 roh anodisé naturel couleur anodisé d'or



product code description
AEO 1 000R rounded / arrondi
 1. mill finish 2. silver anodised 3. color 4. gold anodised
 roh anodisé naturel couleur anodisé d'or

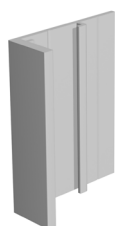

product code description
AEO 1 000.SP straight / droit
 1. mill finish 2. silver anodised 3. color 4. gold anodised
 roh anodisé naturel couleur anodisé d'or

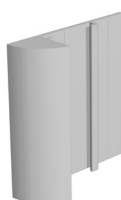

product code description
AEO 1 000R.SP rounded / arrondi
 1. mill finish 2. silver anodised 3. color 4. gold anodised
 roh anodisé naturel couleur anodisé d'or

SUPPORT / DIVIDER PROFILES PROFILÉ DE RENFORT / SÉPARATION



product code omdescription
ANS 1_000 support profile / renfort arrière

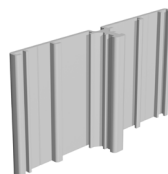

product code omdescription
AEO 1 001 divider profile / profilé lateral double
 1. mill finish 2. silver anodised 3. color 4. gold anodised
 roh anodisé naturel couleur anodisé d'or

SIDE PROFILE COMBINATION PROFILÉS ALLONGÉS



product code description
ARO 1_031 31mm brut, rounded / arrondi 5m/l

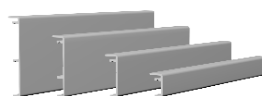

ALO 1_015 15,5mm brut 5m/l
ALO 1_031 31mm brut 5m/l
ALO 1_046 46,5mm brut 5m/l
ALO 1_062 62mm brut 5m/l



ALO 1_031.S 31mm brut, single slider 5m/l
 31mm brut, glissière simple
 1. mill finish 2. silver anodised 3. color 4. gold anodised
 roh anodisé naturel couleur anodisé d'or

FRAME PROFILE PROFILÉ DE CADRE



product code
AEO 1 000F 5m/l
 1. mill finish 2. silver anodised 3. color 4. gold anodised
 roh anodisé naturel couleur anodisé d'or

DIRECTORY TABLEAU DIRECTIONNEL

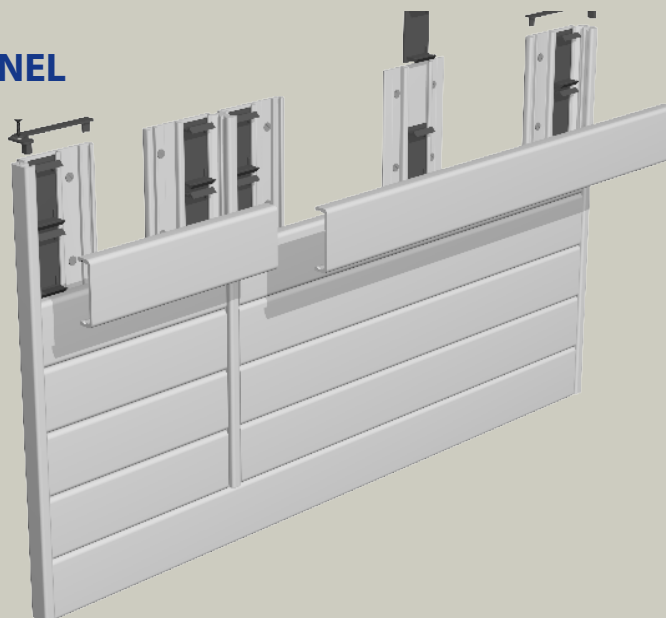

ACCESSORIES / ACCESSOIRES

ENDCAPS FOR SIDE PROFILES CAPUCHONS DE FINITION POUR PROFILÉS LATÉRAUX



product code description
APT 3 000 straight / droit
 2. grey/gris 3. black/noir

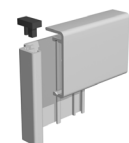

product code description
APT 3 000B straight / droit
 2. grey/gris 3. black/noir



product code description
APT 3 000L rounded / arrondi
 2. grey/gris 3. black/noir

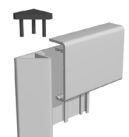

product code description
APT 3 000T triangular / triangle
 2. grey/gris 3. black/noir

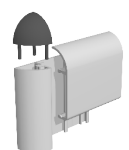

product code description
APT 3 003R rounded / arrondi
 2. grey/gris 3. black/noir

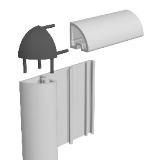

product code description
APT 3 006R for frame profile / pour profilé de cadre
 2. grey/gris 3. black/noir

CLIPS FOR SIDE PROFILES CLIPS POUR PROFILÉS LATÉRAUX



product code description
APC 5000 clips 31mm
APC 5001 clips 15,5mm



product code description
APC5000LS clips 6x31mm

INTERIOR TOTEM TOTEM INTÉRIEURE

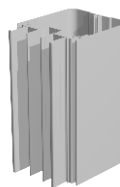

product code profile / profilé
TOT 1 080.SP totem profile 5m/l
 profilé de totem
 1. mill finish brut 2. silver anodised anodisé naturel 3. color couleur



FLOORPLATE metal floorplate
 plaque de sol en métal
 870mm x 200mm



TOPCOVER metal coverplate
 plaque de couverture
 750mm x 80mm

INTERIOR TOTEM TOTEM INTÉRIEURE

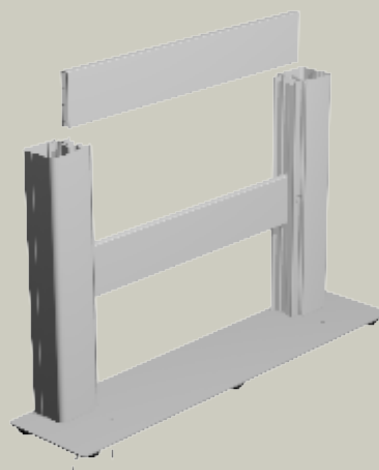
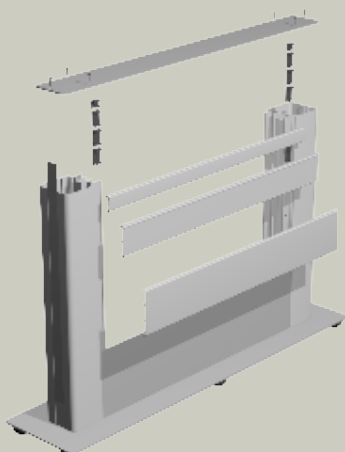

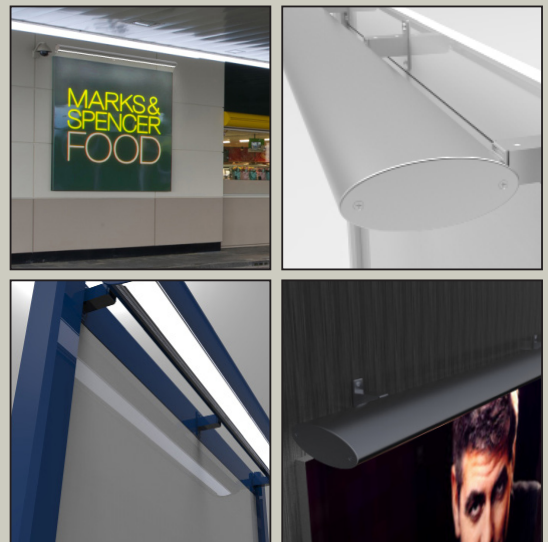
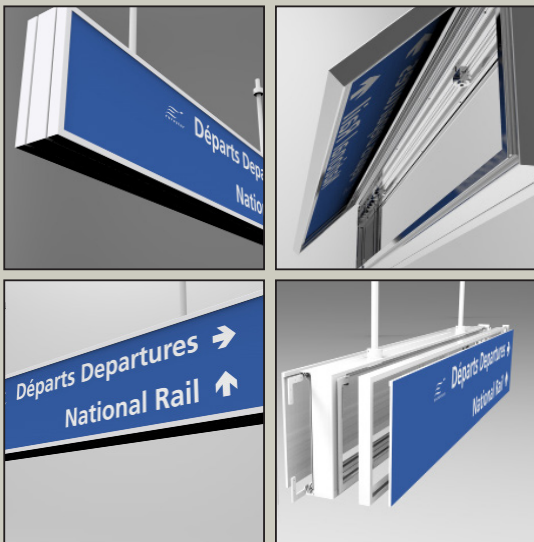

LIGHTBOX

HIGHLIGHT

COSIGN CONTINUES TO DEDICATE ITSELF TO LED SIGNS

LED lighting offers innumerable advantages when compared to traditional light sources. LEDs do not become hot, are energy efficient, safe, sustainable, maintenance free, environmentally friendly and have a long service life.

The developments in the LED industry are taking place at quick succession. Cosign is keeping a close eye on this evolution and, therefore, developed some innovative LED products such as LED THINLITE, SOLED and PROFILED. LED modules can also be used in our new I-SIGN DISPLAY profiles.

Cosign is underscoring its ambitions in the area of LED products by entering into a partnership with the American SloanLED, a trendsetter in LED technology and one of the largest manufacturers of qualitative LED modules for the sign industry in the world and by concluding a joint venture agreement with the British Applelec for the production and marketing of LED Light Sheets.

LED SIGNS

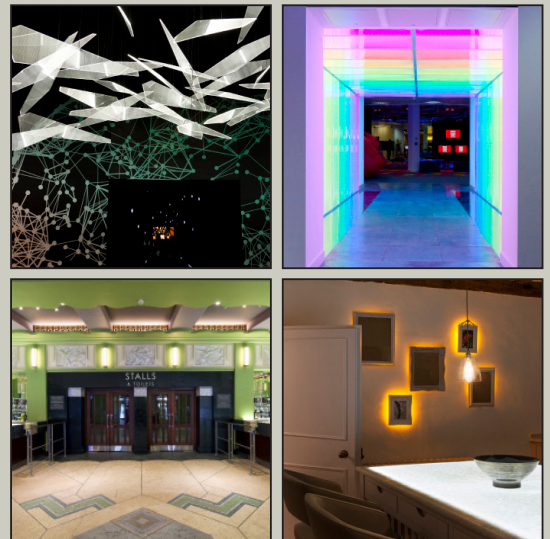
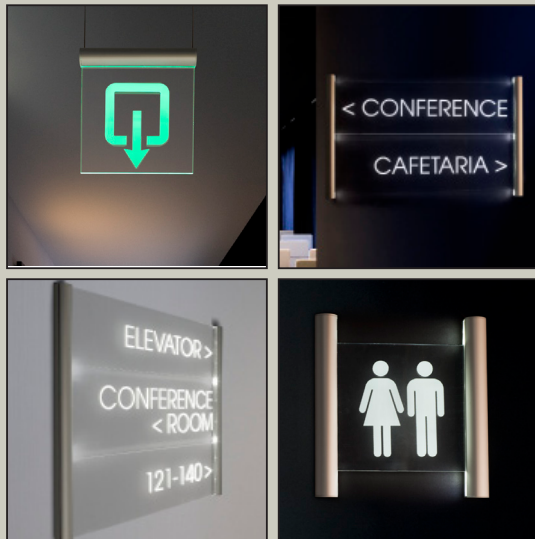

SOLED

LED LIGHT SHEET

COSIGN POURSUIT LE DÉVELOPPEMENT DES ENSEIGNES LED

L'éclairage LED offre de multiples avantages par rapport aux sources de lumière conventionnelles. Les lampes LED ne chauffent pas, elles consomment peu d'énergie, elles sont sûres, durables et écologiques, elles n'exigent aucun entretien, et de surcroît ont une longue durée de vie.

Les développements au sein de l'industrie LED se succèdent à un rythme accéléré. Cosign suit cette évolution de très près et a, dans ce domaine, développé plusieurs produits LED innovants comme le LED THINLITE, SOLED et PROFILED. Les modules LED peuvent également être combinés à nos nouveaux profilés I-SIGN DISPLAY.

Cosign affiche ses ambitions dans le domaine des produits LED, premièrement par la conclusion d'un partenariat avec l'entreprise américaine SloanLED, un pionnier de la technologie LED et un des plus grands fabricants au monde de modules LED de qualité pour l'industrie de l'enseigne, et deuxièmement par la création d'une joint-venture avec l'entreprise anglaise Applelec pour la production et la commercialisation des LED Light Sheets.

LIGHTBOX



www.cosign.be/lightbox

Cosign developed an elegant indoor lightbox with a depth of only 75mm (single-sided) or 100mm (double-sided). The hinging frame on top makes maintenance and a quick change of the acrylic panels and/or graphics extremely easy.

The hinging frame comes in 2 versions. One has the typical I-Sign look with the thin edge. The other one has an edge of 12,5mm which allows for the acrylic panels to be fully illuminated. The perfect lightbox for airports, metro stations, garages, ...

Cosign a développé un caisson lumineux élégant pour l'intérieur avec une profondeur de 75mm (simple face) ou 100mm (double face). Le cadre charnière en haut assure une maintenance facile et un changement rapide des panneaux acryliques et/ou des images.

Le cadre charnière est disponible en 2 versions. L'un a le look typique 'I-sign' avec un bord mince. L'autre a un bord de 12,5mm qui permet d'illuminer les panneaux acryliques complètement. Le caisson lumineux sera parfait pour des aéroports, des stations de métro, garages, ...

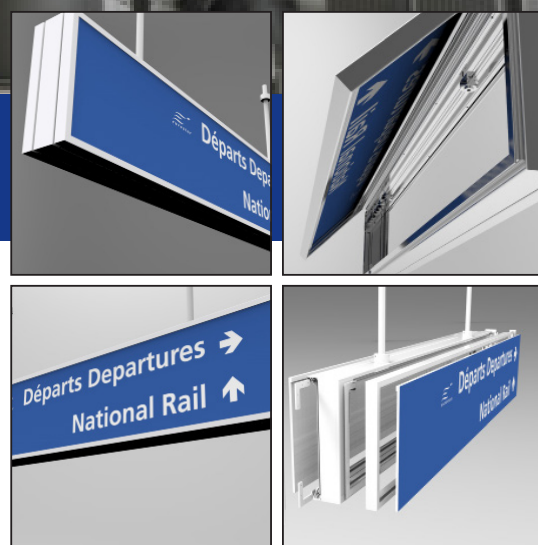

PROFILES & ACCESSORIES / PROFILÉS & ACCESSOIRES

ALUMINIUM PROFILES PROFILÉS ALUMINIUM

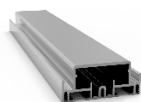

product code description
LB-BASE-DS10 base profile double sided
 profilé base double face
 1. mill finish brut 2. silver anodised anodisé naturel

6,1m/l

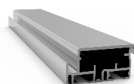

product code description
LB-BASE-SS10 base profile single sided
 profilé base simple face
 1. mill finish brut 2. silver anodised anodisé naturel

6,1m/l



product code description
LB-FRAME-N10 frame profile 12,5mm silver anodised
 profilé de cadre 12,5mm anodisé naturel

6,1m/l



product code description
LB-FRAME-I10 frame profile 1,5mm silver anodised
 profilé de cadre 1,5mm anodisé naturel

6,1m/l



product code description
LB-HINGE hinge profile mill finish
 profilé de charnière

6,1m/l

ACCESSORIES / ACCESSOIRES



product code description
LB-BASE-CORNER corner for base profiles
 pièce d'angle pour profilé base

6,1m/l



product code description
LB-FRAME-CORNER corner for frame profiles
 pièce d'angle pour profilé de cadre

6,1m/l



SINGLE SIDED - FRAME I SIMPLE FACE - CADRE I

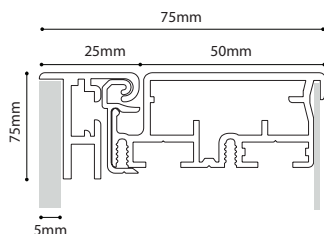

SINGLE SIDED - FRAME N SIMPLE FACE - CADRE N

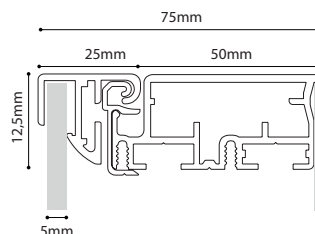

DOUBLE SIDED - FRAME I DOUBLE FACE - CADRE I

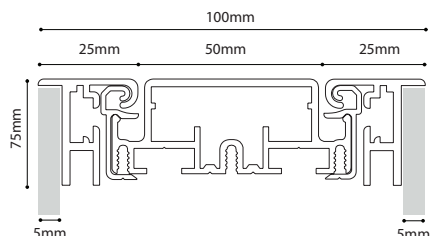

DOUBLE SIDED - FRAME N DOUBLE FACE - CADRE N

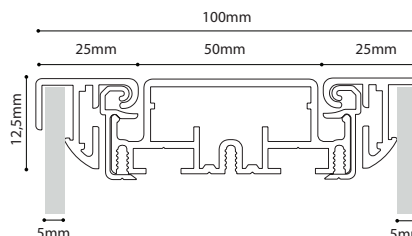

HIGHLIGHT



www.cosign.be/highlight

Highlight is Cosign's new LED luminaire profile which, in combination with the SloanLED® HighLiner II modules or other LED modules, provides the perfect solution for creating decorative wall washers or illuminating large surfaces like billboards, advertising signs, freestanding signs and totem pylons.

The elliptical shaped aluminium profile is supplied including endcaps, a special LED diffusing opal polycarbonate cover, easy-to install wall brackets, spacer profiles and a hinge bracket which allows the profile to be set in the right angle to ensure an optimal light distribution.

La combinaison du Highlight, le nouveau profilé Cosign pour luminaire LED, avec les modules SloanLED® HighLiner II ou autres modules LED offre la solution idéale pour créer des lèches-murs décoratifs ou illuminer de grandes surfaces telles que panneaux publicitaires, enseignes isolées, totems ou pylônes.

Le profilé aluminium de section elliptique est fourni avec les embouts, un couvercle diffuseur spécial LED en polycarbonate semi-opaque, des attaches murales faciles à installer, des profilés d'écartement et une attache charnière qui permet d'ajuster l'angle du profilé pour assurer une distribution optimale de la lumière.



PROFILES & ACCESSORIES / PROFILÉS & ACCESSOIRES

ALUMINIUM PROFILES PROFILÉS ALUMINIUM

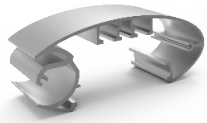

product code	description	
HL-PROF 1 000	highlightprofile profilé de highlight	6,1m/l
	1. mill finish brut	
	2. silver anodised anodisé naturel	

ENDCAP / CAPUCHON



product code	description
HL-CAP 1 000	endcap / capuchon
	1. mill finish brut
	2. silver anodised anodisé naturel

WALL BRACKET / SUPPORT DE MONTAGE



product code	description
HL-WB 1 000	wall bracket / support de montage
	1. mill finish brut
	2. silver anodised anodisé naturel

COVER PROFILE / PROFIL ---



product code	omschrijving	
HL-PC-OPAL	Polycarbonate cover profile	6,1m/l

SPACER / SUPPORT DE MONTAGE



product code	description	
HL-SP 1 000	spacer 30x30x2mm	3m/l
	1. mill finish brut	
	2. silver anodised anodisé naturel	

HINGE BRACKET / SUPPORT DE MONTAGE



product code	description
HL-HB 1 000	hinge bracket
	1. mill finish brut
	2. silver anodised anodisé naturel

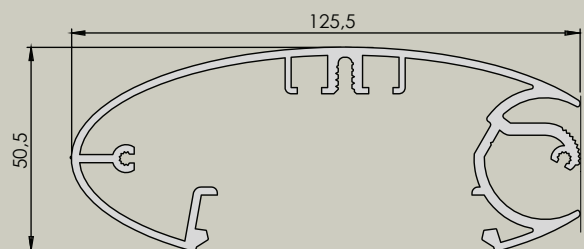
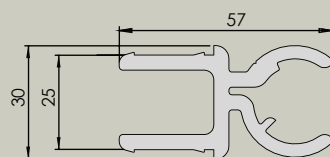
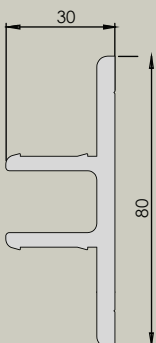

SOLED

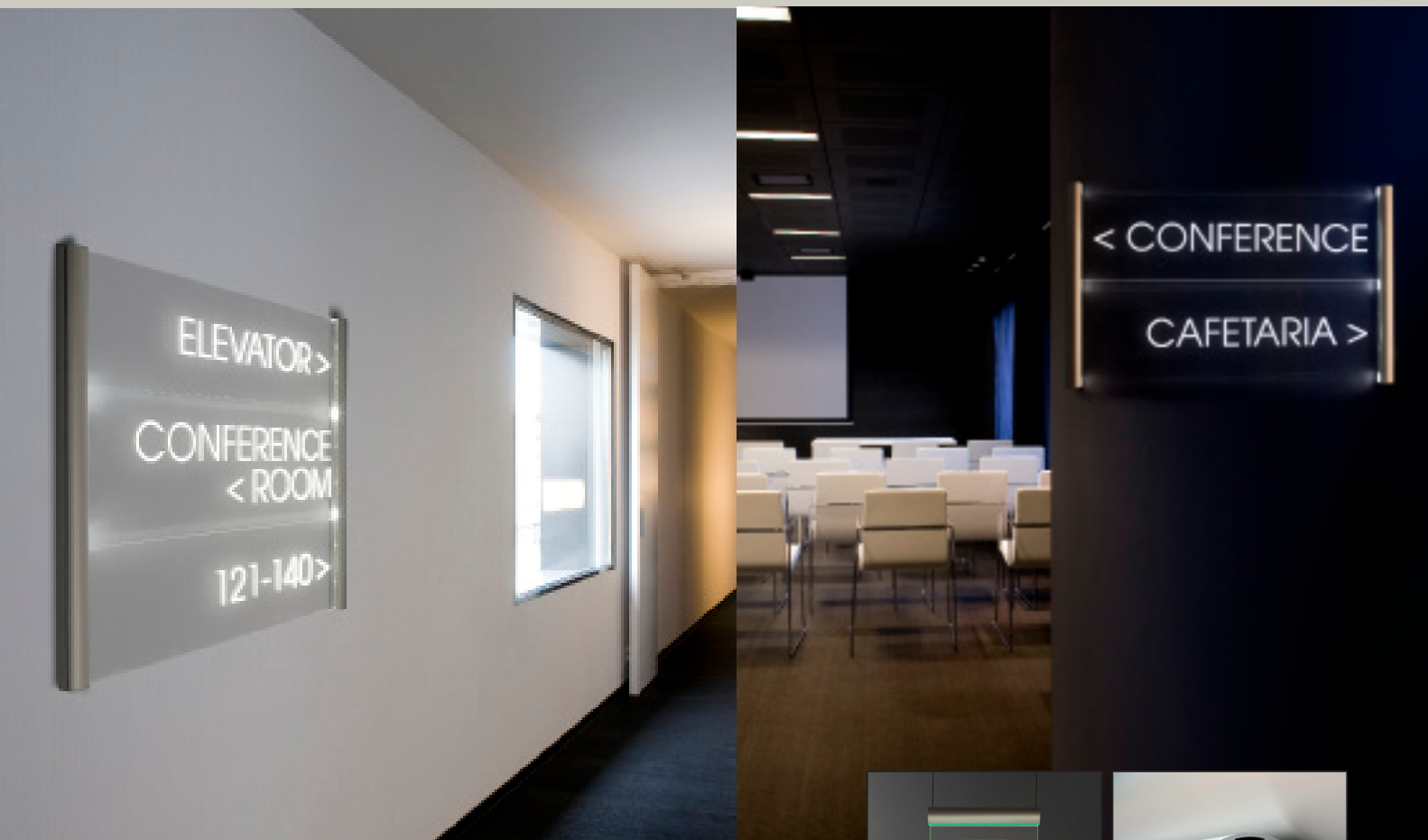

www.cosign.be/soled

SOLED is an architectural sign application where a LED strip is integrated into the profiles that ensures the light is introduced in a glass or acrylic sheet from the side. This ensures that the image on the front of the sheet is lit up. The image can easily be added to the sheet using a film or it can be engraved into the sheet.

SOLED is a modular system where the customer can choose between a round, curved or square profile and where the signs can be wall mounted, suspended or flag mounted.

SOLED est un système d'enseignes architecturales dans lequel une bande lumineuse LED est incorporée dans les profilés de façon à projeter la lumière latéralement dans une plaque de verre ou d'acrylate, et ainsi éclairer l'image située à l'avant-plan. L'image peut être fixée très facilement à l'aide d'un film adhésif, ou être gravée sur la plaque elle-même.

Dans le système modulaire SOLED, le client a le choix entre un profilé arrondi, courbe ou rectangulaire. De plus, les enseignes peuvent être suspendues au plafond ou fixées sur un mur, soit à plat, soit perpendiculairement à celui-ci.



PROFILES & ACCESSORIES / PROFILÉS & ACCESSOIRES

ALUMINIUM PROFILES PROFILÉS ALUMINIUM

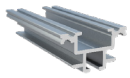

product code profile / profilé
SOL_1000.B base / structure 5m/l

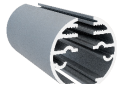

SOL_1000.R round / rond 5m/l

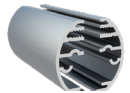

SOL_1000.C ellipse / elliptique 5m/l

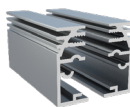

SOL_1000.S square / carré 5m/l
1. mill finish brut 2. silver anodised anodisé naturel

ALUMINIUM ENDCAPS CAPUCHONS ALUMINIUM



product code description
SOLCAP08.R round / rond (8mm)



SOLCAP12.R round / rond (12mm)



SOLCAP08.C ellipse / elliptique (8mm)



SOLCAP12.C ellipse / elliptique (12mm)



SOLCAP08.S square / carré (8mm)



SOLCAP12.S square / carré (12mm)



SOLCAP08.SC combined / combinaison (8mm)



SOLCAP12.SC combined / combinaison (12mm)

PROJECTING BRACKET SUPPORT DE MONTAGE EN DRAPEAU



product code description
SOLBRAC08 for plates 8mm / pour panneaux 8mm
SOLBRAC12 for plates 12mm / pour panneaux 12mm

HANGING CLIP / CLIP DE SUSPENSION



product code
APC3000S

HANGING KIT / KIT DE SUSPENSION



product code description
APC4101 2x conical clip + 1,5m wire
2x clip conique + 1,5m fil

See also page 54 for more suspension systems.
Pour plus d'infos sur les systèmes de suspension, voyez également sur la page 54.

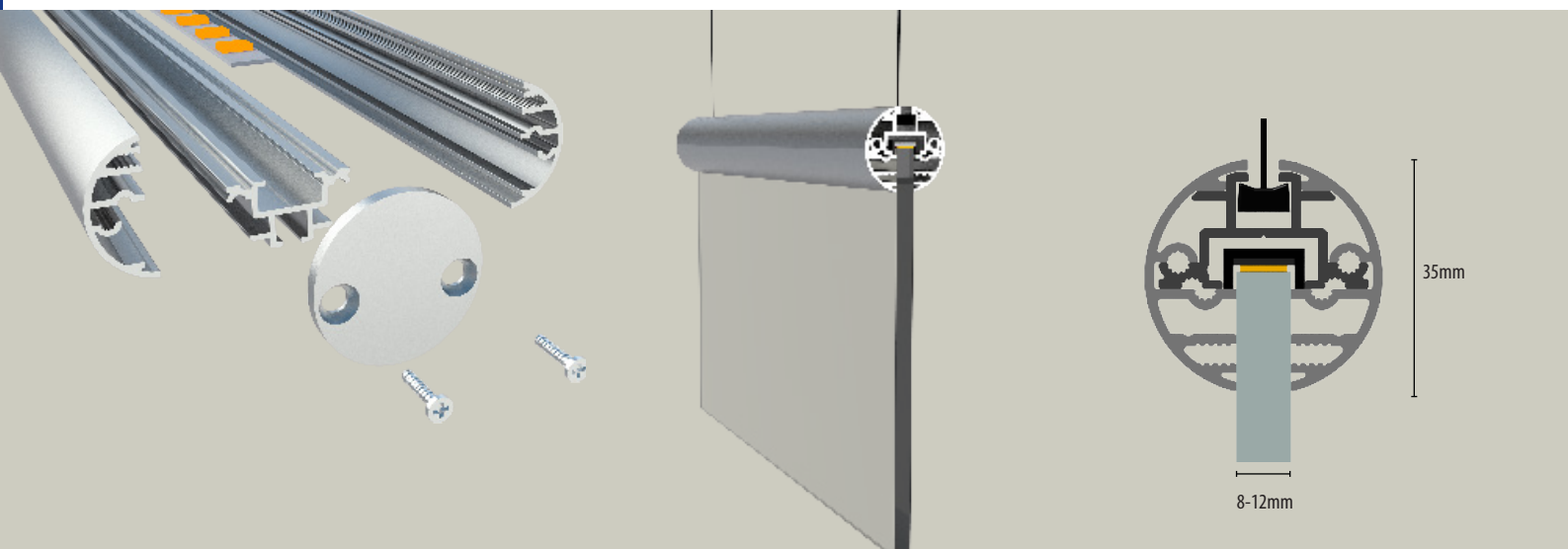

LED LIGHT SHEETS



www.ledlightsheet.be

LED Light Sheets are thin acrylic sheets with embedded LEDs. The specific composition of the product as well as adding an optical pattern with the patented V-cut technology or a personalised dot pattern with laser technology ensures a uniform distribution of light.

LED Light Sheets can be supplied in all sizes and shapes with white LEDs in various colour temperatures or with RGB LEDs. LED Light Sheets are mainly used indoors and in display and sign projects where the available space/depth to integrate a source of light is limited.

Les LED Light Sheets sont de minces plaques acryliques à l'intérieur desquelles sont installées des lampes LED. La répartition uniforme de la lumière est assurée par la composition spécifique du produit ainsi que par l'utilisation d'un motif de quadrillage, gravé à l'aide de la technologie brevetée V-cut, ou d'un motif personnalisé de petites sphères gravé au laser.

Les LED Light Sheets sont disponibles dans toutes les formes et dimensions, et équipés de LED RVB ou de LED blanches de diverses températures de couleur. Les LED Light Sheets sont principalement utilisés dans des projets d'affiches ou d'enseignes d'intérieur pour lesquels l'espace ou la profondeur disponibles pour installer la source lumineuse sont limités.

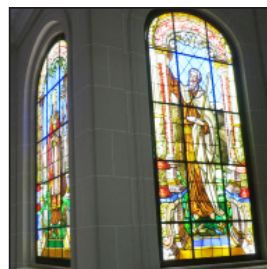

TECHNICAL SPECIFICATIONS / CARACTÉRISTIQUES TECHNIQUES

Material Matériau	Acrylic / Acrylate (PMMA)
Thickness Épaisseur	6mm, 8mm, 10mm (RGB Leds / LED RVB)
Pattern Motif	V-cut optical pattern / Motif de quadrillage V-cut (1,4mm - 2,8mm - 5,6mm) Laser dot pattern (personalised) Motif de sphères gravé au laser (personnalisé)
Max. size Dimensions maximales	3000mm x 1500mm
LED	5630 SMD LED (0,25W P=15mm)
Input voltage Tension d'alimentation	AC 100 - 240V 50/60Hz
Operating voltage Tension de service	DC 12V - 24V
Efficiency Rendement	120lm / W
Colour temperature Température de couleur	3000K, 3700K, 4100K, 5300K, 6000K, 6500K, RGB
CRI Indice de rendu de couleur	65 - 90
Degree of protection Classe de protection	IP54 - IP67
Service life Durée de vie	>50.000 uur (L ₇₀)
Guarantee Garantie	LED Light Sheets (3 years / 3 ans) - acrylic / Acrylate (5 years / 5 ans)
Operating temperature Température de service	-30°C tot +40°C -30°C à +40°C
Accessories Accessoires	Power supplies, connectors, splitters, RGB drivers, dimmers. Sources d'alimentation, connecteurs, répartiteurs, contrôleurs de RVB, gradateurs.



TEXTILE FRAME



COSIGN TEXTILE FRAMES: INFINITE POSSIBILITIES

Textile frames are the solution for the fast and easy exchange of printed textile fabrics. The image is printed on a textile fabric and a silicon beading is added around it. This is simply pressed into the profile that ensures that the slightly stretchable fabric can be stretched perfectly.

The convenience of use of our aluminium profiles in combination with innovative accessories and high-quality textile fabrics that can be printed up to 3 m wide seamlessly means that our textile frames are perfectly suitable for dressing and setting up shops, showrooms, offices and fair stands. Regardless of whether you want a wall frame or a standalone or hanging frame, you will find the right solution with our single- and double-sided textile profiles.

Cosign also offers LED profiles in which you can integrate High Power LED modules that will ensure that the fabric is lit up uniformly and the image is done even better justice. You can also include a noise-dampening material behind the printed fabric to improve the acoustics of a room or to create partitions.

You will not just find the profiles and accessories at Cosign, you can also order the full custom-made product including the printed fabric.



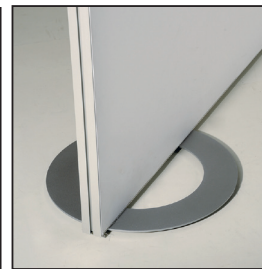
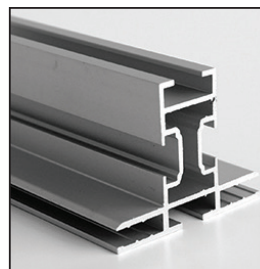
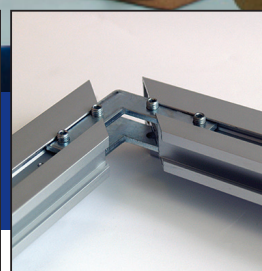
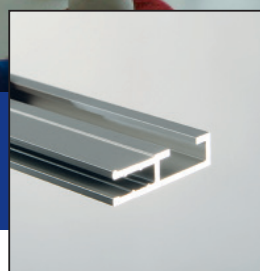

LES CADRES TEXTILE DE COSIGN : DES POSSIBILITÉS INFINIES





Les cadres tissu tendu sont la solution idéale pour pouvoir remplacer rapidement et facilement les tissus imprimés. L'image est imprimée sur un tissu, et tout le périmètre de ce dernier est muni d'une bande en silicone. La bande s'insère facilement dans le profilé de façon à tendre parfaitement le tissu légèrement extensible.

La facilité avec laquelle nos profilés en aluminium peuvent être combinés à des accessoires innovants et à des tissus de haute qualité, susceptibles d'être imprimés sans jointure sur une largeur atteignant 3 m, fait de nos cadres tissu tendu la solution idéale pour l'habillement et l'aménagement de magasins, showrooms, bureaux et stands de foires. Que vous recherchiez une enseigne à fixer au mur, à suspendre ou à poser librement, vous trouverez certainement une solution adaptée dans notre collection de profilés pour tissu tendu simple face ou double face.

Cosign propose également des profilés LED dans lesquels peuvent s'intégrer des modules LED High Power de façon à éclairer uniformément le tissu et à mettre encore plus en valeur l'illustration. Il est également possible d'ajouter un matériau insonorisant derrière le tissu afin d'améliorer l'acoustique d'un local ou de créer des cloisons.

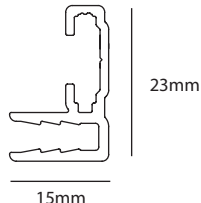
PROFILES / PROFILÉS

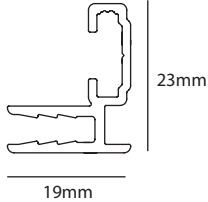
SINGLE-SIDED TEXTILE FRAME PROFILES / PROFILÉS POUR CADRES TEXTILE SIMPLE FACE

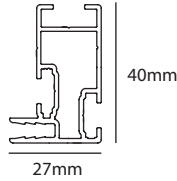
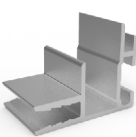
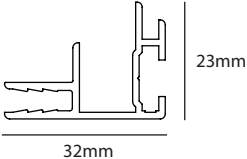
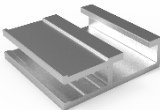
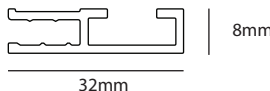
	product code	profile / profilé		
	TEXSSLD15	15x23mm (light duty)	6,1mtr	
	TEXSSLD19	19x23mm (light duty)	6,1mtr	
	TEXSSHD27	27x40mm (heavy duty)	6,1mtr	
	TEXLLS32	32x23mm (Led Light Sheet)	6,1mtr	
	TEXNICHE	32x8mm (niche)	3mtr	

DOUBLE-SIDED TEXTILE FRAME PROFILES / PROFILÉS POUR CADRES TEXTILE DOUBLE FACE

	product code	profile / profilé		
	TEXDSD44	44x40mm (heavy duty)	6,1mtr	
	TEXDSL45	45x15mm	3mtr	

PROFILES / PROFILÉS

TEXTILE LED FRAME PROFILES / PROFILÉS POUR CADRES TEXTILE LED

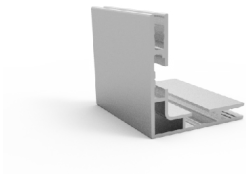
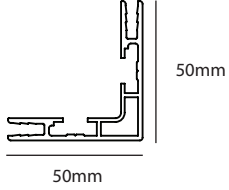
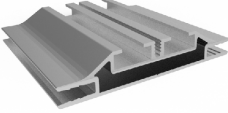
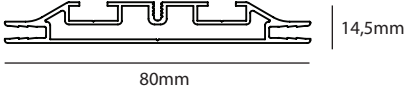
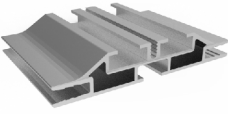
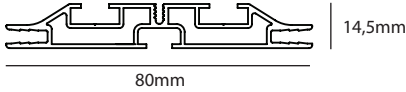
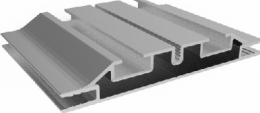
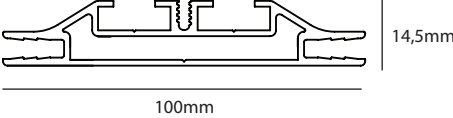
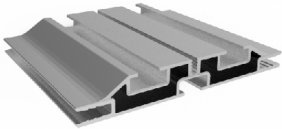
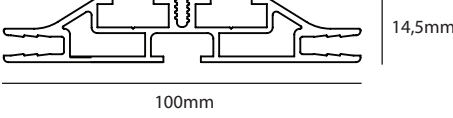
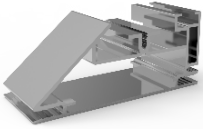
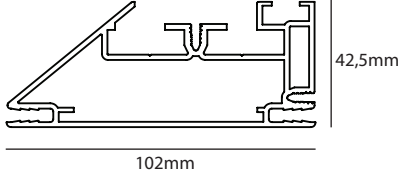
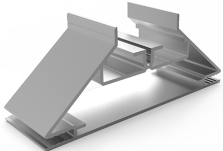
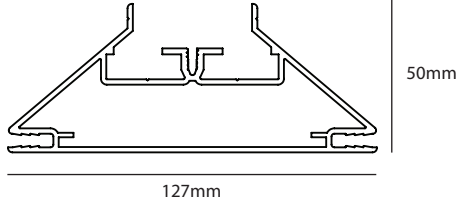
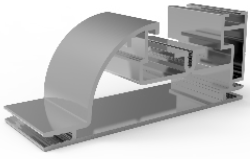
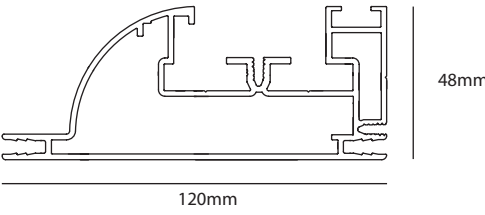
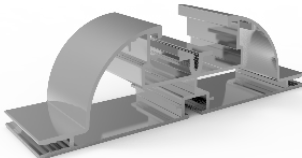
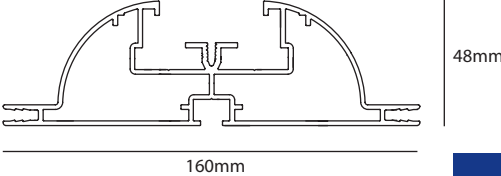
	product code	profile / profilé	
	TEXLED50	160x48mm	6,1mtr 
	TEXLED80	80x14,5mm	6,1mtr 
	TEXLED80T	80x14,5mm	6,1mtr 
	TEXLED100	100x14,5mm	6,1mtr 
	TEXLED100T	100x14,5mm	6,1mtr 
	TEXLEDSS-BL	102x42,5mm	6,1mtr 
	TEXLEDSS-BL	127x50mm	6,1mtr 
	TEXLEDSS-EL	120x48mm	6,1mtr 
	TEXLEDSS-EL	160x48mm	6,1mtr 

PROFILES & ACCESSORIES / PROFILÉS & ACCESSOIRES

CORNER CONNECTORS CONNECTEURS D'ANGLE

product code description



TEXCORN5

for profile / pour profilé
TEXSSH27, TEXNICHE, TEXDSDL45

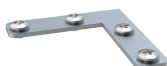

TEXCORN1

for profile / pour profilé
TEXSSLD15, TEXSSLD19, TEXSSHD27,
TEXDSD44, TEXLLS32



TEXCORN1

for profile / pour profilé
TEXLEDD5(BL/EL), TEXLEDD5(BL/EL)



TEXCORN2

for profile/ pour profilé
TEXLED80, TEXLED80T
TEXLED100, TEXLED100T
TEXLED50



CONNECTOR1

for profile/ pour profilé
TEXSSLD15, TEXSSLD19, TEXSSHD27,
TEXLLS32, TEXDSD44, TEXNICHE



CONNECTOR2

for profile/ pour profilé
TEXSSH27, TEXDSD44,
TEXLED50



CONNECTOR3

for profile/ pour profilé
TEXLED55 (BL/EL), TEXLEDD5 (BL/EL)



CONNECTOR4

for profile/ pour profilé
TEXLED80, TEXLED80T
TEXLED100, TEXLED100T

SUSPENSION CLIP CLIP SUSPENSION

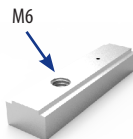

product code

description

TEXHANG1

metal suspension clip for 1.5mm cable/
clip suspension metal pour cable
TEXDSD44, TEXLEDD5-EL

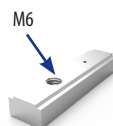

TEXHANG2

metal suspension clip for M6 rod/threaded
bar/ clip suspension metal
TEXLED80T / TEXLED100T

MOUNTING BRACKET SUPPORT DE MONTAGE EN DRAPEAU

product code

description

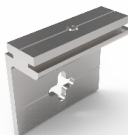

TEXBRACKET1

Wall mounting bracket for
TEXLED55(BL/EL), TEXSSH27



TEXBRACKET2

Wall mounting bracket for
TEXLED80, TEXLED80T
TEXLED100, TEXLED100T

H-SUPPORT PROFILE PROFILÉ DE RENFORT-H

product code

profile / profilé



TEX-H

36x19mm 3mtr

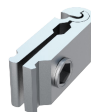

TEXCLAMP

for profile / pour profilé
TEX-H

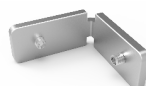

TEXCORNH

connector for profile/
connecteur pour profilé
TEXLED55 (BL/EL) + TEX-H
TEXLEDD5 (BL/EL) + TEX-H

PROFILES & ACCESSORIES / PROFILÉS & ACCESSOIRES

MOUNTING CLIP CLIP DE MONTAGE

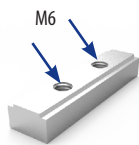

product code description
TEXMOUNT1 metal clip for M6 rod/threaded bar/
 clip metal
 TEXDSD44 / TEXLEDDS-EL

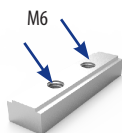

product code description
TEXMOUNT2 metal clip for M6 rod/threaded bar/
 clip metal
 TEXLED80T / TEXLED100T

STANDING KIT KIT DEBOUT

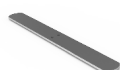

product code description
TEXFOOT40 foot / pied 400mm



product code description
TEXFOOT60 foot / pied 600mm



product code description
TEXFEETSIDE side support / support latéral

FLOOR PLATES PIEDS



TEXCIRCLE circle / circle \varnothing 450 x 6mm



TEXHOOP hoop / cerceau \varnothing 450 x 6mm



TEXBASE baseball / base-ball 450 x 300 x 6mm



TEXFILLET fillet / balafre 500 x 180 x 6mm



STANDING KIT / KIT DEBOUT	PROFILE / PROFILÉ	FEET / PIEDS			CONNECTORS / CONNECTEURS	
		TEXFOOT40	TEXFOOT60	TEXFEETSIDE	TEXMOUNT1	TEXMOUNT2
TEXKIT40-1	TEXDSD44 / TEXLEDDS-EL	v			v	
TEXKIT40-1S	TEXDSD44 / TEXLEDDS-EL	v		v	v	
TEXKIT60-1	TEXDSD44 / TEXLEDDS-EL		v		v	
TEXKIT60-1S	TEXDSD44 / TEXLEDDS-EL		v	v	v	
TEXKIT40-2	TEXLED80T / TEXLED100T	v				v
TEXKIT40-2S	TEXLED80T / TEXLED100T	v		v		v
TEXKIT60-2	TEXLED80T / TEXLED100T		v			v
TEXKIT60-2S	TEXLED80T / TEXLED100T		v	v		v

Note:

v = Accessories and screws are included in the kit. / Other textile profiles without track can be used as a freestanding kit while using drill holes.

Remarque:

v = Les accessoires et les vis sont inclus dans le kit. / D'autres profilés de textile sans rainure peuvent être utilisés comme kit autoportant tout en utilisant des trous de forage.

TENSION PROFILES



www.cosign.be/tension

The Cosign Tension System is one of the most popular solutions for the professional installation of banners, flexface and other printed textiles including mesh and canvas. A very simple and versatile product, it is easy to use and requires no special tools.

It is the perfect solution for a wide range of graphics and display projects.:

- Indoor and Outdoor signage projects
- Lightboxes
- Building wraps

Le système Tension de Cosign est une des solutions les plus largement utilisées pour le montage professionnel de bannières, de Flexface et d'autres textiles imprimés comme la toile ou le tissu de maille. Un produit très simple et versatile, il est facile à utiliser et ne requiert aucun outil spécial.





Le système est la solution idéale pour un large éventail de projets de graphisme et d'affichage :

- Projets de signalétique intérieure et extérieure
- Enseignes lumineuses
- Habillages de bâtiments

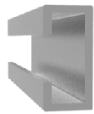

PROFILES & ACCESSORIES / PROFILÉS & ACCESSOIRES



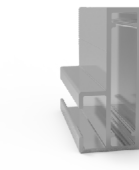
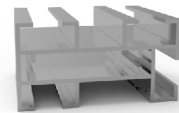

TENSION PROFILES PROFILÉS TENSION

	product code U SECTION10	description U profil / profilé U	3,06m/l
	product code U+ SECTION10	description U+ profil / profilé U+	3,06m/l
	product code UU SECTION10	description UU profil / profile UU	3,06m/l
	product code UU COVER20	description UU cover profil geanodiseerd Profilé de couverture pour profilé UU	3,06m/l

TENSION PROFILES PROFILÉS TENSION

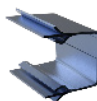
	product code U 2SECTION10	description U2 profil / profilé U2	3,06m/l
	product code UU2 SECTION10	description UU2 profil / profilé UU2	3,06m/l

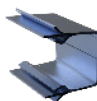
ACCESSOIRES FOR TENSION PROFILES ACCESSOIRES POUR PROFILÉS TENSION

	product code PLASTICTSBLACK	description Tension Strip black / Strip tension noir
	product code PLASTICTSGREY	description Tension Strip grey / Strip tension gris
	product code PLASTICTSWHITE	description Tension Strip white / Strip tension blanc
	product code UUSPRING	description Spring Clips for UU cover Clips couverture UU
	product code CORNERCON	description Corner connector for U2 and UU2 profiles Connecteur d'angle pour U2 et UU2 profilé
	product code STRAIGHTCON	description Straight connector for U2 and UU2 profiles Connecteur pour U2 et UU2 profilé

U PROFILE / PROFILÉ U



U+ PROFILE / PROFILÉ U+



UU PROFILE / PROFILÉ UU



FIXINGS



www.cosign.be/fixings

TIMELESS ELEGANCE

Over the last 10 years, Cosign has become the leading manufacturer of standoffs & sign fixings in the Benelux. Our designers chose to create fixings in an austere and modern design, in high-quality stainless steel (AISI 303 and 304).

Even though the sign fixings were designed for indoor use, many customers also use them outdoors in non-aggressive environments. Environments with chlorine, salt and metallic fumes must be avoided.

The design takes into account compatibility with sheets of glass. We use silicon rings to protect the sheets of glass or set screws with a nylon tip wherever possible.

Starting in 2015, all our standoffs & sign fixings spacers will also be available in stylish silver anodised aluminium and in a blister pack that will include the wall screws, plugs and allen keys.

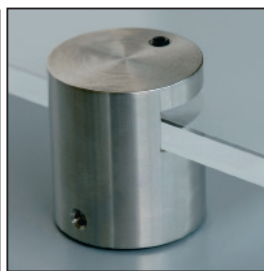
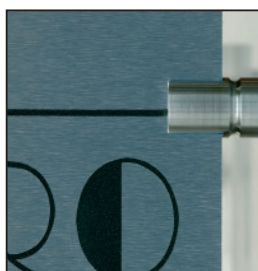

ELEGANCE INTEMPORELLE

Au cours de ces 10 dernières années Cosign est devenu le principal fabricant d'entretoises dans le Benelux. Nos designers ont dès le début opté pour des entretoises d'un design sobre et moderne et pour une finition en acier inoxydable de qualité élevée (AISI 303 et 304).

Bien que les entretoises aient été conçues pour l'intérieur, elles sont aussi utilisées par de nombreux clients pour l'extérieur dans des environnements non agressifs. Bien sûr il convient toujours d'éviter les environnements avec du chlore, des sels et des vapeurs métalliques.

Lors de la conception il a été tenu compte avec la compatibilité avec des panneaux de verre. Ainsi il est fait usage au maximum de bagues de silicone afin de protéger le panneau de verre ou on utilise des vis de serrage avec une pointe en nylon.

A partir de 2015 nos entretoises seront aussi proposées avec une finition aluminium anodisée argentée très stylée dans un emballage sous blister pratique contenant également les vis murales, les chevilles et les clés de réglage.

DISTANCE HOLDERS / FIXATIONS DE TABLEAUX

MOUNT BUTTONS / DÉCOCAPS

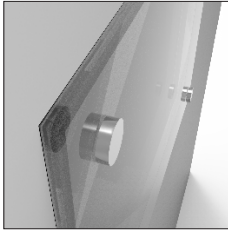

code inox code inox	code aluminium code aluminium	diameter (A) diamètre
MB130000	MB130000-A	13mm
MB180000	MB180000-A	18mm

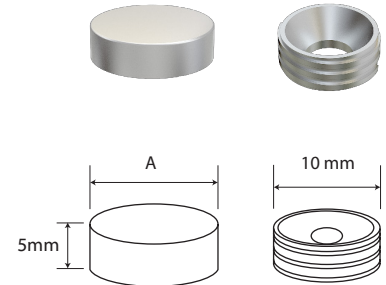
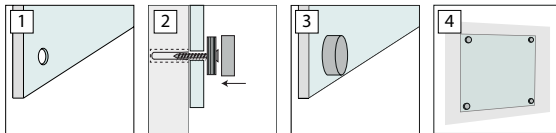

THROUGH HOLE PANEL SUPPORTS / FIXATIONS MURALES PERCÉES



code inox code inox	code aluminium code aluminium	diameter (A) diamètre	projection (B) projection	panel thickness épaisseur	diameter drillhole trou de forage
DH131507	DH131507-A	13mm	15mm	2-7mm	8mm
DH132012	DH132012-A	13mm	20mm	2-12mm	8mm
DH181507	DH181507-A	18mm	15mm	2-7mm	12mm
DH182512	DH182512-A	18mm	25mm	2-12mm	12mm
DH302512	DH302512-A	30mm	25mm	2-12mm	15mm

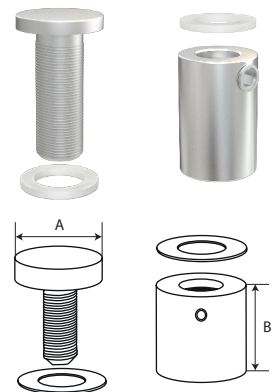
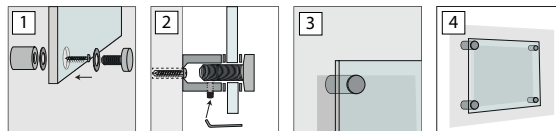

SIDE GRIP PANEL SUPPORTS / FIXATIONS MURALES FENDUES



code inox code inox	code aluminium code aluminium	diameter (A) diamètre	projection (B) projection	panel thickness épaisseur
SG182008	SG182008-A	18mm	20mm	max 8mm
SG302008	SG302008-A	30mm	20mm	max 8mm

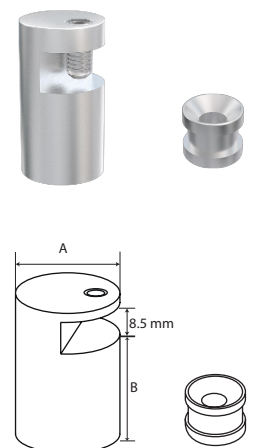
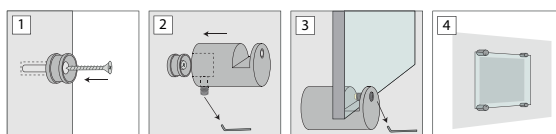

DISTANCE HOLDERS / FIXATIONS DE TABLEAUX

WALL-CEILING PANEL GRIPS / SUPPORTS MUR-PLAFOND



code inox code inox	code aluminium code aluminium	diameter diamètre	panel thickness épaisseur
WG170008	WG170008-A	17mm	max 8mm

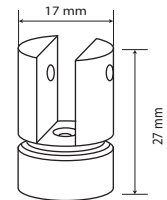
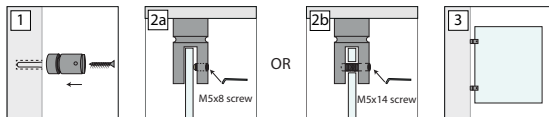

SUSPENSION KIT / KIT SUSPENDU

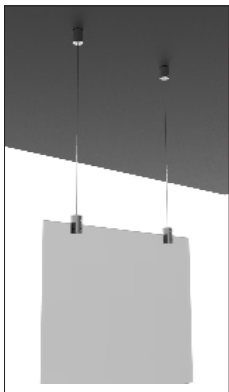

code inox code inox	code aluminium code aluminium	diameter diamètre	panel thickness épaisseur	description description
CC15HP06	CC15HP06-A	17mm	max 6mm	suspension clamp support pour panneau suspendu
CC15KIT4	CC15KIT4-A	17mm	max 6mm	suspension kit incl. ceilingconnector and wire. kit suspendu, fixation plafond et câble inclus.

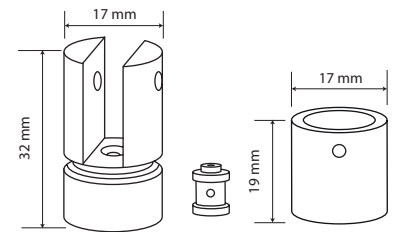
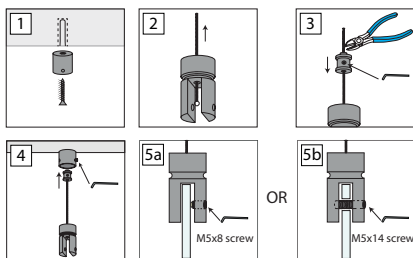

SUSPENSION KITS



www.cosign.be/suspension

EASE OF USE

Cosign developed a range of suspension systems which guarantee an easy, cost effective and safe suspension of signage, lighting systems, cable trays and other applications.

All systems have a built-in locking mechanism that grips cables automatically. To release, just press the clutch button, and the cable is free to move back and forth to achieve the desired length.

Our suspension range offers a solution for all types of ceilings: conventional ceilings, suspended ceilings, ceilings with metal tiles or high open ceilings with visible structural supports.

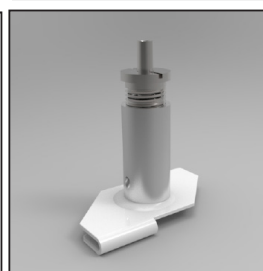
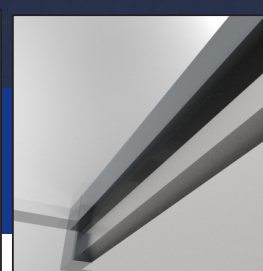

FACILITÉ D'UTILISATION

Cosign a développé une série de systèmes de suspension qui garantissent un montage simple, bon marché et sécurisé des panneaux signalétiques, systèmes d'éclairage, supports de câbles et autres applications.

Tous les systèmes sont équipés d'un dispositif de verrouillage intégré qui serre automatiquement les câbles. Pour les libérer, il suffit d'appuyer sur le bouton de verrouillage, ce qui permet de déplacer les câbles d'avant en arrière pour obtenir la longueur souhaitée.

Notre gamme de systèmes de suspension offre une solution pour tous les types de plafonds : plafond conventionnel, plafond suspendu, plafond couvert de cassettes métalliques ou encore haut plafond ouvert avec supports structurels visibles.

SUSPENSION SYSTEMS / SYSTÈMES DE SUSPENSION

SUSPENSION CLIPS / CLIPS DE SUSPENSION

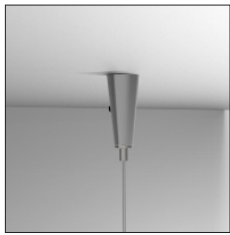

code	description	cable thickness	max weight
APC-4001	Suspension Clip Conical	max 1.5mm	20,0kg

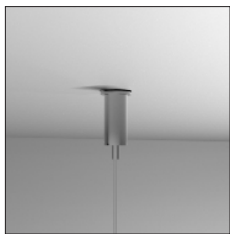

code	description	cable thickness	max weight
APC-4002	Suspension Clip Cylindrical	max 1.5mm	20,0kg



code	description	cable thickness	max weight
APC-4003	Suspension Clip Eco	max 1.5mm	20,0kg



CABLE

code	description	cable thickness	max weight
APC-CABLE-1.5	Galvanized cable (7x7). 1,5m length with 4,5mm ball nipple.	1.5mm	16kg



NOTE:

Always consider maximum load of any used part of the total suspension system.

Il est important de toujours tenir compte du poids maximum de chaque utilisée du système de suspension totale.

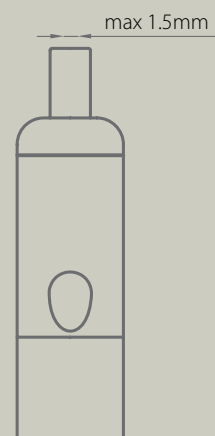
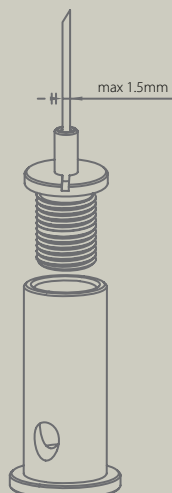

SUSPENSION SYSTEMS / SYSTÈMES DE SUSPENSION

MAGNETIC ANCHOR / ANCRE MAGNÉTIQUE



code	description	cable thickness	max weight
APC-MG32	Magnetic Anchor 32mm incl gripper	max 1.5mm	2kg



DOUBLE GRIPPER

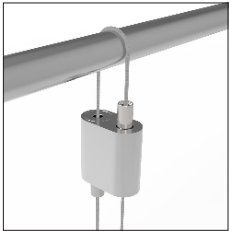

code	description	cable thickness	max weight
APC-DG15-B	Double Gripper 1.5mm Black	max 1.5mm	20kg
APC-DG15-S	Double Gripper 1.5mm Silver	max 1.5mm	20kg
APC-DG30-B	Double Gripper 3.0mm Black	max 3,0mm	90kg
APC-DG30-S	Double Gripper 3.0mm Silver	max 3,0mm	90kg



TWISTER CLIPS

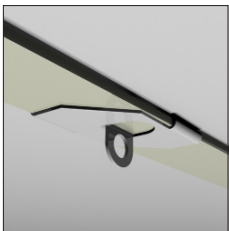

code	description	cable thickness
APC-TW00	Twister Clip with 5,6mm loop	-
APC-TW03	Twiser Clip with Gripper	max 1.5mm

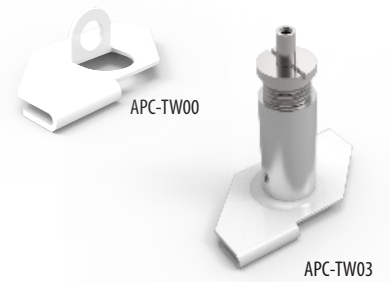

magnet strength: N35

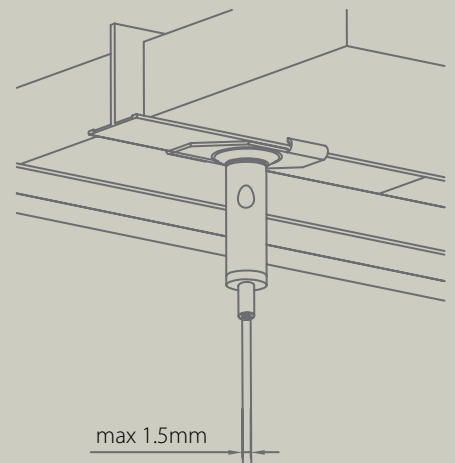
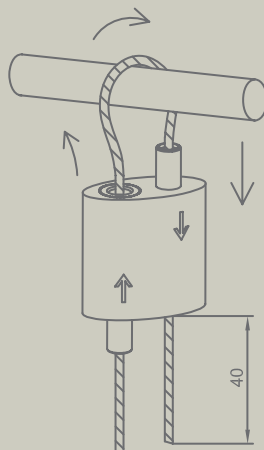

MODULE PLUS OUTDOOR



www.cosign.be/moduleplusoutdoor

STYLISH MODULAR OUTDOOR SIGNS

With Module Plus Outdoor, Cosign has developed a modular system for outdoor signs that is often prescribed by architects and designers worldwide and that sign makers like to use because of its versatility and convenience and the option of making unique custom-made signs.

Module Plus Outdoor offers the perfect solution everywhere where a building or location needs to be indicated, a message must be presented or people must be shown the correct place regardless of whether this is for an industrial estate, a company or office building, a hospital, a school, a shopping centre or a car park. Appropriate outdoor signs will also contribute towards strengthening a company's corporate identity.

The Module Plus Outdoor system consists of a series of round, square and ellipse-shaped aluminium poles and text panels (box profiles) with a height of 46 mm, 60 mm, 100 mm, 120 mm, 150 mm, 200 mm and 250 mm. The text panels can be fixed by using special panel clamps. Other innovative accessories ensure that panels can be integrated that are made of different materials in any required size.





SIGNALISATION EXTÉRIEURE MODULAIRE PARTICULIÈREMENT RAFFINÉE

Avec le Module Plus Outdoor, Cosign a lancé un système modulaire de signalisation extérieure fréquemment prescrit par les architectes et designers du monde entier et souvent utilisé par les fabricants d'enseignes du fait de sa grande polyvalence, de sa facilité d'utilisation, et de la possibilité de réaliser des enseignes uniques entièrement sur mesure.

Le Module Plus Outdoor constitue la solution idéale chaque fois qu'il est nécessaire d'indiquer un bâtiment ou un lieu, d'afficher un message ou d'orienter les visiteurs vers un endroit particulier, que ce soit dans un zoning industriel, un bâtiment d'entreprise, un immeuble de bureaux, un hôpital, une école, un centre commercial ou un parking. Une signalisation extérieure de qualité contribue également au renforcement de l'image de marque de l'entreprise.

Le système Module Plus Outdoor se compose d'une série de poteaux en aluminium de section ronde, carrée ou elliptique, ainsi que de panneaux à texte en aluminium (profilés du type caisson) d'une hauteur de 46, 60, 100, 120, 150, 200 ou 250 mm. Les panneaux à texte sont fixés à l'aide d'attaches spéciales. D'autres accessoires innovants permettent d'intégrer des panneaux de toute taille, fabriqués en différents types de matériaux.

PROFILES & ACCESSORIES / PROFILÉS & ACCESSOIRES

ALUMINIUM POLES POTEAUX ALUMINIUM

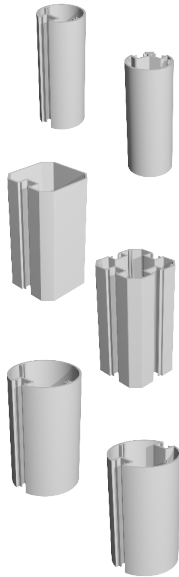

product code	description	
A00 1 6001T	60mm round, 1-slot	6m/l
A00 1 6002T	60mm round, 2-slots 60°	5m/l
A00 1 8081T	80mm octagonal, 1-slot	5m/l
A00 1 8084T	80mm octagonal, 4-slots	5m/l
A00 1 9001T	90mm round, 1-slot	6m/l
A00 1 9002T	90mm round, 2 slots 180°	5m/l

1. mill finish brut
 2. silver anodised anodisé naturel
 3. color couleur

ALUMINIUM ENDCAPS CAPUCHONS ALUMINIUM



product code	description	∅
AOT601 1	round / rond	60mm
AOT 1 090	round / rond	90mm

1. mill finish brut
 2. silver anodised anodisé naturel
 3. color couleur

PLASTIC ENDCAPS CAPUCHONS PLASTIQUES



product code	description	∅
AOT6001	round / rond	60mm
AOT8081	octagonaal / octagonal	80mm
AOT8084	for octagonal, 4 slots pour octagonal, 4 slots black acrylic / acrylic noir	80mm

1. white/blanc 2. grey/gris 3. black/noir

DOUBLE SIDED TEXTPANELS CAISSONS DOUBLE FACE

product code	description	
A00 1 250	250mm	5m/l
A00 1 200	200mm	5m/l
A00 1 150	150mm	5m/l
A00 1 120	120mm	5m/l
A00 1 100	100mm	5m/l
A00 1 060	60mm	5m/l
A00 1 046	46mm	5m/l

1. mill finish brut
 2. silver anodised anodisé naturel
 3. color couleur

250 200 150 120 100 60 46 mm

PANEL CLAMP CRAMPONS DE FIXATION



product code	description
AACL001	with steel screw / avec vis acier
AACL002	with inox screw / avec vis inox



FIXBOX001	without screw / sans vis
-----------	--------------------------



FIXBOX002	with screw / avec vis
-----------	-----------------------



TOOL001	drilling guide / gabarit de perçage
---------	-------------------------------------

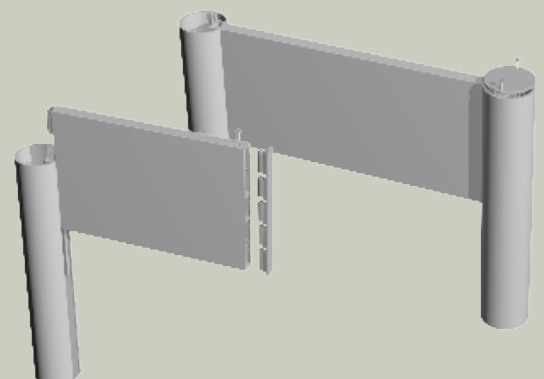
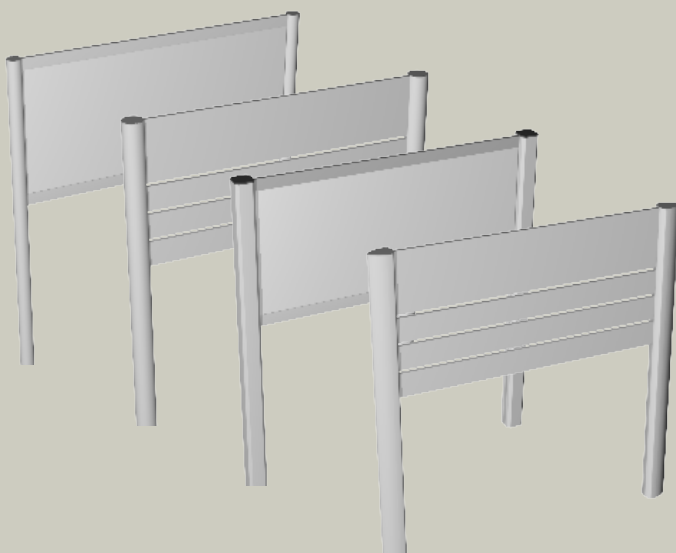

PROFILES & ACCESSORIES / PROFILÉS & ACCESSOIRES

FINISHING PROFILES PROFILÉS DE FINITION

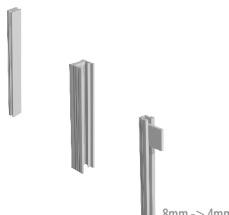

8mm -> 4mm

product code	description
AOCO_1_00	finishing profile / profilé de finition
ADAPTER_1_0	adapter profile / profilé de connection
AORO_1_00	reduction profile / profilé de reduction

1. mill finish brut 2. silver anodised anodisé naturel 3. color couleur

ALUMINIUM ENDCAPS PROFILÉS ALUMINIUM OBTURATEUR POUR CAISSONS

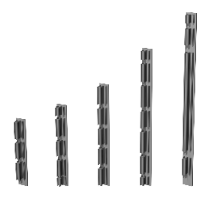

product code	description
AOC_1_250	250mm
AOC_1_200	200mm
AOC_1_150	150mm
AOC_1_120	120mm
AOC_1_100	100mm

1. mill finish brut 2. silver anodised anodisé naturel 3. color couleur

STEEL FEET / PIEDS EN ACIER

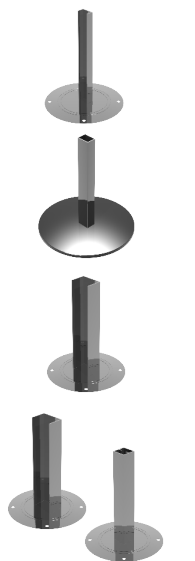

product code	description
FEE1600	60mm round pole / poteau rond
DECOFEE2600	decorative foot / pied décoratif 60mm round pole / poteau rond
FEE19001T FEE19002T	90mm round pole / poteau rond, 1-slot 90mm round pole / poteau rond, 2-slots
FEE18081T FEE18084T	80mm pole / poteau octagonal, 1-slot 80mm pole / poteau octagonal, 4-slots

ROUND CORNER CONNECTOR ANGLE ARRONDI



CORN_1_090 mill finish, for round pole 90mm
brut, pour poteau rond 90mm

ELLIPTICAL POLES POTEAUX ÉLLIPTIQUES

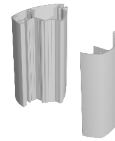

ELP_1_000 base profile / profilé de base 5m/l
ELP_1_001 hinge profile / profilé charnière 5m/l



AOT_1_000 elliptical endcap
capuchon elliptique
AOC_1_000 finishing profile / profilé de finition 5m/l

1. mill finish brut 2. silver anodised silver eloxiert 3. color farbe

LIGHTING ACCESSORIES ACCESSOIRES D'ÉCLAIRAGE



For more info, see page 34.
Pour plus d'infos voyez également sur la page 34.

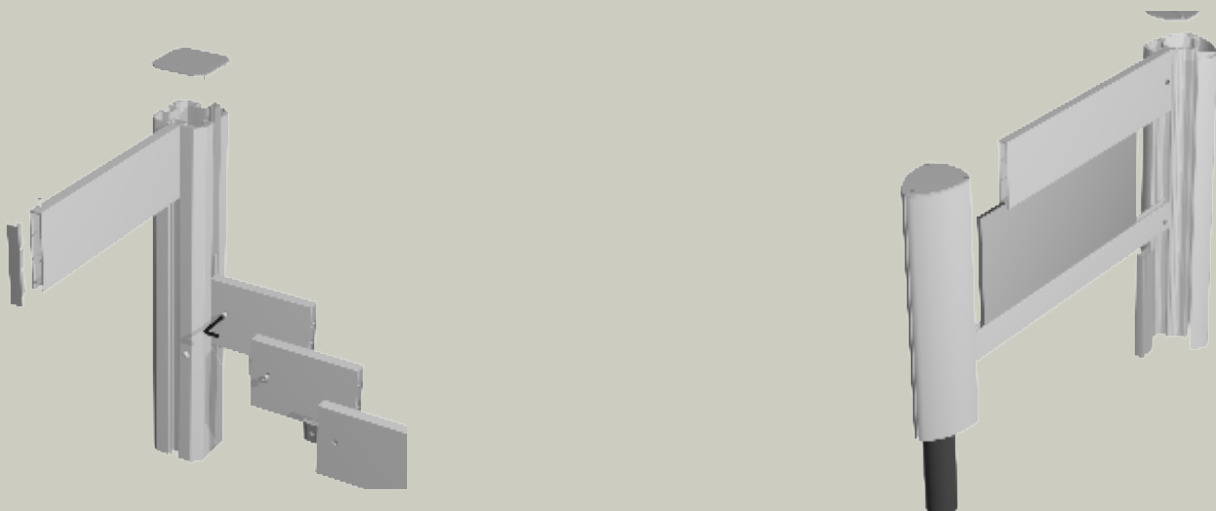

ADVERTISING PILLARS
INFORMATION PILLARS
ORIENTATION PILLARS
SIGNPOSTING

COLONNES PUBLICITAIRES
COLONNES INFORMATIVES
TOTEMS D'ORIENTATION
PANNEAUX DE SIGNALISATION



TOTEM PYLON

TOP-CLASS

Advertising pillars are omnipresent on today's street scene. A carefully designed advertising pillar makes you easier to find and contributes to the brand awareness and corporate identity of a company.

Cosign is an important manufacturer of profiles and accessories required for building advertising pillars or totems in the Benelux. We only deliver to the sign industry. In addition to the 'classical' range of totem profiles, Cosign developed a modular system with Modular Totem that sign makers can use to construct totems in a chosen shape.

Depending on the chosen profile and internal structure, the sign maker can make small, elegant indoor totems as well as large, sturdy totems of up to 6 metres high.

Cosign will offer profiles and accessories as well as a series of ready-made totems, flat or oval, of exceptional quality to professional sign makers starting in 2015.

TOTEM

GRANDE CLASSE

On n' imagine plus de nos jours les rues sans totems publicitaires. Une colonne publicitaire astucieusement conçue non seulement met les gens sur la bonne voie, elle contribue aussi à une notoriété et à une image de marque accrues de l'entreprise.

Dans le Benelux, Cosign est un fabricant important de profils et d'accessoires nécessaires pour ériger des colonnes publicitaires ou totems et il ne livre qu'à l'industrie de la signalisation. Outre la gamme 'classique' de profils de totem, Cosign a développé avec Modular Totem un système modulaire avec lequel le fabricant peut construire des totems ayant la forme de son choix.

En fonction du profil choisi et de la structure interne, le fabricant de signalisations peut réaliser aussi bien de petits totems d'intérieur élégants que de grands totems solides pouvant atteindre une hauteur de 6 mètres.

A partir de 2015, Cosign propose au fabricant de signalisations professionnel non seulement des profils et des accessoires, mais aussi une série de totems prêts d'usine, plans ou ovales, d'une qualité exceptionnelle.

TOTEM PYLON



www.cosign.be/totempylon

Everyone is familiar with Cosign's 'classic' totem profiles, which are used to make illuminated or non-illuminated elegant, curved or elliptical advertising pillars.

Depending on the application, location and desired size, the sign maker can choose our totem pylon 50 mm or totem pylon 80 mm for smaller totems (up to 3 metres) or our totem pylon 137 mm and the more recent H-profile for larger totems (up to 6 metres).

Tout le monde les connaît, les profils de totem 'classiques' de Cosign qui permettent de fabriquer d'élégantes colonnes publicitaires courbées ou de forme elliptique, avec ou sans éclairage.

En fonction de l'application, de l'emplacement et de la taille voulue, le fabricant a le choix parmi notre totem pylon 50 mm et le totem pylon 80 mm pour les totems plus petits (jusqu'à 3 mètres), et le totem pylon 137 mm et le plus récent profil en H pour les totems plus grands (pouvant atteindre 6 mètres).

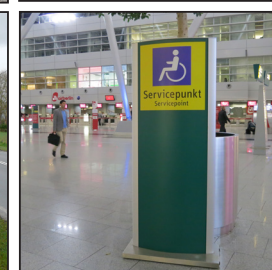

ALUMINIUM PROFILES

PROFILÉS EN ALUMINIUM

ELLIPSE 50mm ÉLLIPSE 50mm

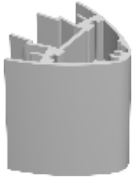

product code	profile / profilé	
TOT 1 050	50mm	6m/l
	1. mill finish brut	2. silver anodised anodisé naturel
		3. color couleur

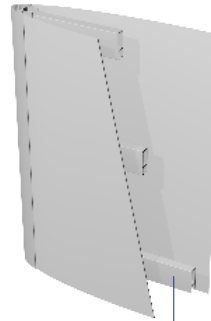

Double sided sign support 46mm (A001046)
Caisson 46mm (A001046)

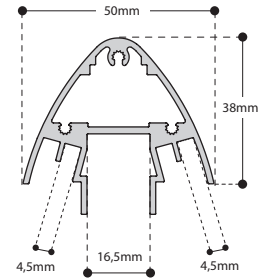

ELLIPSE 80mm ÉLLIPSE 80mm

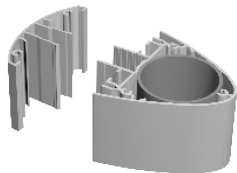

product code	profile / profilé	
TOT 1 080	80mm	6m/l
	1. mill finish brut	2. silver anodised anodisé naturel
		3. color couleur
TOTCLOSE1080	afsluiting / couverture	6m/l
	1. mill finish brut	2. silver anodised anodisé naturel
		3. color couleur

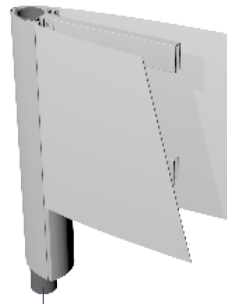

Round tube 50 x 4mm
Tube rond 50 x 4mm

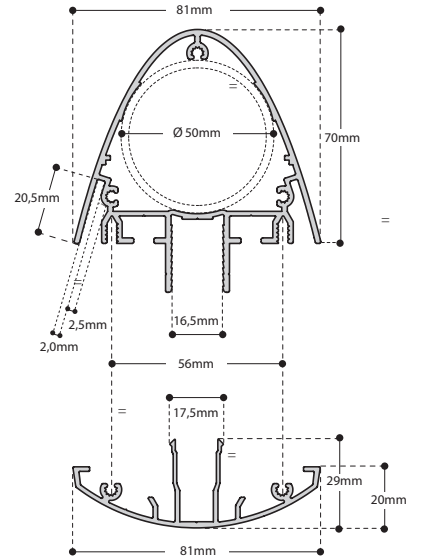

ELLIPSE 137mm ÉLLIPSE 137mm

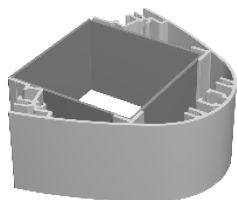

product code	profile / profilé	
TOT 1 137	137mm	6m/l
	1. mill finish brut	2. silver anodised anodisé naturel
		3. color couleur

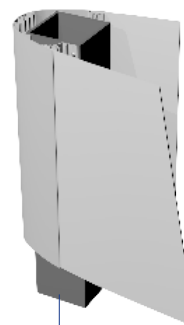

Aluminium or steel profile 80 x 80 x 4mm
Tube de fondation 80 x 80 x 4mm

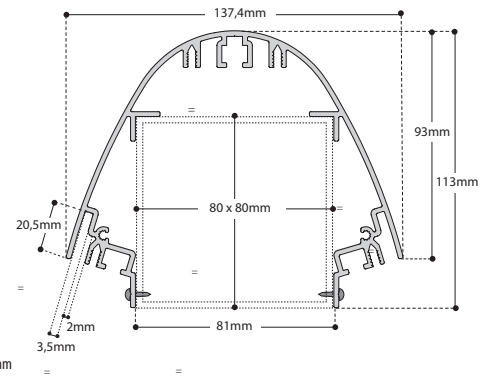

H-PROFILE PROFILE-H

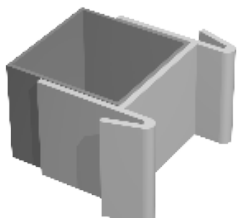

product code	profile / profilé	
TOTH 1 060	H, 60mm	6m/l
	1. mill finish brut	2. silver anodised anodisé naturel
		3. color couleur



Aluminium or steel profile 60 x 60 x 4mm
Tube de fondation 60 x 60 x 4mm

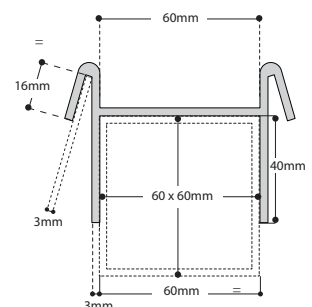

COSIGN

ARCHITECTURAL SIGNAGE



ARCHITECTURAL SIGNAGE | TEXTILE FRAMES | POS PRODUCTS | LED SOLUTIONS

Cosign is a designer, manufacturer and distributor of architectural signage & way finding solutions, poster frames & displays, led modules and sign making tools. Based in Belgium with regional offices in Mexico, Brazil and India, and through our global partner network, our sign solutions are available in more than 80 countries.

Cosign est un concepteur, fabricant et distributeur de solutions de signalétique & orientation architecturale, de cadres & supports de posters, de modules LED et d'outils de signalétique. Nous sommes basés en Belgique et possédons des antennes régionales au Mexique, Brésil et en Inde. Grâce à notre réseau mondial de partenaires, nos solutions d'affichage sont disponibles dans plus de 80 pays.

COSIGN

YOUR DEALER / VOTRE REVENDEUR:

COSIGN nv
Industriepark 32 B
B-3290 Diest
Belgium
www.cosign.be

